

RADIO'S LIVEST MAGAZINE



November
25 Cents

Radio-Craft

HUGO GERNSBACK Editor

283 - Service Bench

281 - Business

The
"Half-Wave Mast-Antenna"

See Page 269



The Dynamic Microphone — An Analyzer for Fast Servicing — How Meters Operate
Tuning Without Condensers — A Direct-Reading Conductance Meter — Short-Wave Craft

SPEED

RADIO TUBES FOR ALL NEW RECEIVERS

EVER ABREAST OF THE RADIO TIMES

SPEED has achieved tremendous success
with these NEW tubes. The reason
is obvious—QUALITY



247

New power amplifier Pentode, for
use in the output stage of AC
receivers.

Here They Are!

No. 235

New screen grid tube—designed to reduce
cross modulation and similar distortion.

No. 551

New screen grid tube—designed for same
purpose as type 235, although having
slightly different characteristics.

No. 230

New general purpose tube, operating eco-
nomically at 2 volts, giving unusual service
though using very little power.

No. 231

New amplifier using 2 volts and extremely
low current consumption in same group as
types 230 and 232.

No. 232

New screen grid tube—for use as radio
frequency amplifier, operating at 2 volts.

No. 233

New power amplifier in the Pentode group,
operating on 2 volts with low current con-
sumption.

No. 236

New screen grid tube used mainly as R.F.
amplifier or detector in automobile sets.
In same group as type 237 and 238. Also
for use in D.C. sets.

No. 237

New general purpose tube—especially
adapted to automobile use. Can be used
either as a detector or amplifier. Also for
use in D.C. sets.

No. 238

New power amplifier Pentode for use in
automobile receivers designed for it. Gives
unusual volume for small input signal
strength.

No. S 84

Developed expressly for replacement of
type C 484 in Sparton sets. Somewhat
similar in characteristics to the type 227.

No. S 82 B

Developed expressly for replacement of the
C 183 in Sparton sets, possessing all
peculiar characteristics necessary for this
purpose.

No. S 83

Developed expressly for replacement of
the C 183 in Sparton sets, possession all
the peculiar characteristics necessary for
this purpose.

SPEED Quality is Making History Today. Write for Complete Details.

Still another addition to a big family. **SPEED** FOTO-LECTRIC TUBES.
Standard gas-filled type, red sensitive, caesium on caesium-oxide silver-oxide.
Six months guarantee against defects. Write for FOTO-LECTRIC folder.



SPEED
CABLE RADIO TUBE CORPORATION

230-240 NORTH 9th STREET, BROOKLYN, NEW YORK

RCA
LICENSED

Train *with* R.T.A. *for* Radio Service Work

Important and far-reaching developments in Radio create sudden demand for specially equipped and specially trained Radio Service Men.



*This excellent
set analyzer
and trouble
shooter included
with our course
of training*

MANY skilled Radio Service Men are needed now to service all-electric sets. By becoming a certified R. T. A. Service Man, you can make big money, full time or spare time, and fit yourself for the big-pay opportunities that Radio offers.

We will quickly give you the training you need to qualify as a Radio Service Man . . . certify you . . . furnish you with a marvelous Radio Set Analyzer. This wonder instrument, together with our training, will enable you to compete successfully with experts who have been in the radio business for years. With its help you can quickly diagnose any ailing Radio set. The training we give you will enable you to make necessary analysis and repairs.

Serving as a "radio doctor" with this Radio Set Analyzer is but one of the many easy ways by which we help you make money out of Radio. Wiring rooms for Radio, installing and servicing sets for dealers, building and installing automobile Radio sets, constructing and installing short wave receivers . . . those are a few of the other ways in which our members are cashing in on Radio.

As a member of the Radio Training Association, you receive personal instruction from skilled Radio Engineers. Upon completion of the training, they will advise you personally on any problems which arise in your work. The Association will help you make money in your spare time, increase your pay, or start you in business. The easiest, quickest, best-paying way for you to get into Radio is by joining the Radio Training Association.

This amazing Radio Set Analyzer plus the instructions given you by the Association will transform you into an expert quickly. With it, you can locate troubles in all types of sets, test circuits, measure resistance and condenser capacities, detect defective tubes. Knowing how to make repairs is easy; knowing what the trouble is requires expert knowledge and a Radio Set Analyzer. With this Radio Set Analyzer, you will be able to give expert service and make big money. Possessing this set analyzer and knowing how to use it will be but one of the benefits that will be yours as a member of the R. T. A.

Write for No-Cost Membership Plan

We have worked out a plan whereby a membership enrollment need not cost you a cent. Our thorough training and the valuable Radio set analyzer can be yours. Write at once and find out how easily both of these can be earned.

Now is the time to prepare to be a Radio Service Man. Greater opportunities are opening up right along. For the sake of extra money in your spare time, bigger pay, a business of your own, a position with a future, get in touch with the Radio Training Association of America now.

Send for this No-Cost Membership plan and Free Radio Handbook that will open your eyes as to what Radio has in store for the ambitious man. Don't wait. Do it now.

RADIO TRAINING ASSOCIATION OF AMERICA
Dept. RCA-11 4513 Ravenswood Ave. Chicago, Ill.

Fill Out and Mail Today!

RADIO TRAINING ASSOCIATION OF AMERICA
Dept. RCA-11 4513 Ravenswood Ave., Chicago, Ill.

Gentlemen: Send me details of your No-Cost Membership Enrollment Plan and information on how to learn to make real money in radio quick.

Name

Address

City..... State.....

H. GERNSBACK, President
 S. GERNSBACK, Treasurer
 J. M. HERZBERG, Vice-President
 I. S. MANHEIMER, Secretary



R. D. WASHBURN, Technical Editor

LOUIS MARTIN Associate Editor

VOLUME III
 NUMBER 5

Contents of This Issue

NOVEMBER
 1931

	PAGE		PAGE
EDITORIAL:			
Extra Money for Service Men.....By Hugo Gernsback	267	RADIO SERVICE DATA SHEETS:	
		No. 53—Stromberg-Carlson Models 19 and 20.....	284
		No. 54—RCA-Victor Radiola Console Model R-13....	285
NEW DEVELOPMENTS IN RADIO:			
Television Aids the Blind.....	268	Unusual Sources of Interference.....By William Murrills	287
The "Half-Wave Mast-Antenna".....	269	Servicing Spartans, Brunswicks, and Majestics	
The Dynamic Microphone.....By Louis Martin	270	By Bertram M. Freed	286
Permeability Tuning.....By R. D. Washburne	271	A "Speed Tester" for Radio Service Men	
New Devices in Radio.....	272	By R. Douglas Clerk	310
SERVICE MEN'S DEPARTMENT:			
"Haywire Antennas" vs. the Antennaplex System		SOUND RECORDING DEPARTMENT:	
(Part II).....By E. Jay Quinby	275	Recording Amplifiers and Level Indicators	
Magic in Meters (Part I).....By Clifford Denton	278	By George J. Saliba	288
The Service Man's Forum.....	281	Sound Recording Questions and Answers.....	296
A 1000-Ohms-Per-Volt Multi-Range A. C. Voltmeter		TECHNICAL RADIO TOPICS:	
By R. D. Leonard	282	Sound Equipment in the Hotel New Yorker, (Part IV);	
A Direct-Reading Conductance Meter		The Design of Remote Control Apparatus	
By C. H. W. Nason	282	By Eli M. Lurie	276
A Practical Service Bench.....By Harry F. Sewall	283	The "Tropic 10" Short-Wave "Superhet"	
		By George Brooks	290
		Radio Short-Cuts.....By Radio-Craft Readers	292
		The Radio Craftsman's Page.....By Himself	294
		RADIO-CRAFT'S Information Bureau.....	296
		A Distortionless Detector Circuit.....By C. H. W. Nason	298

In Forthcoming Issues

SOME NOTES ON THE DESIGN OF R.F. COILS. An informative article from a different angle on a subject which always is of interest to radio men.

SELLING MULTI-WAVE SUPERHETERODYNES. How to increase your income by selling to your customers in its most convenient form a radio receiver of advanced design.

INSIDE A COMMERCIAL RADIO LABORATORY. Every technician has his own idea of just what constitutes a "perfect" laboratory; the comparison, therefore, will be of interest.

RADIO ON HORSEBACK. The modern King Arthur rides to the fray on a horse caparisoned with "radio saddlebags"; while the rider's lance has become an antenna.

RADIO-CRAFT is published monthly, on the fifth of the month preceding that of date; its subscription price is \$2.50 per year. (In Canada and foreign countries, \$3.00 a year to cover additional postage.) Entered at the postoffice at Mt. Morris, Ill., as second-class matter under the act of March 3, 1879. Trademarks and copyrights by permission of Gernsback Publications, Inc., 98 Park Place, New York City.

Text and illustrations of this magazine are copyright and must not be reproduced without permission of the copyright owners. We are also agents for WONDER STORIES and WONDER STORIES QUARTERLY. Subscriptions to these magazines may be taken in combination with RADIO-CRAFT at reduced Club rates. Write for information.

Copyright 1931, GERNSBACK PUBLICATIONS, INC.

Published by
TECHNI-CRAFT PUBLISHING CORPORATION

Publication Office: 404 No. Wesley Ave., Mount Morris, Illinois

Editorial and Advertising Offices

96-98 Park Place, New York City

Chicago Advertising Office

737 North Michigan Avenue, Chicago, Ill.

Western Advertising Office

220 No. Catalina St., Los Angeles, Calif.

L. F. McCLURE, Chicago Advertising Representative

London Agent: Hachette & Co.,

3 La Belle Sauvage, Ludgate Hill, E.C. 4

LOYD B. CHAPPELL, Western Advertising Representative

Paris Agent: Hachette & Co.,

111 Rue Reaumur

Australian Agent: McGill's Agency,

179 Elizabeth St., Melbourne



The Old Way

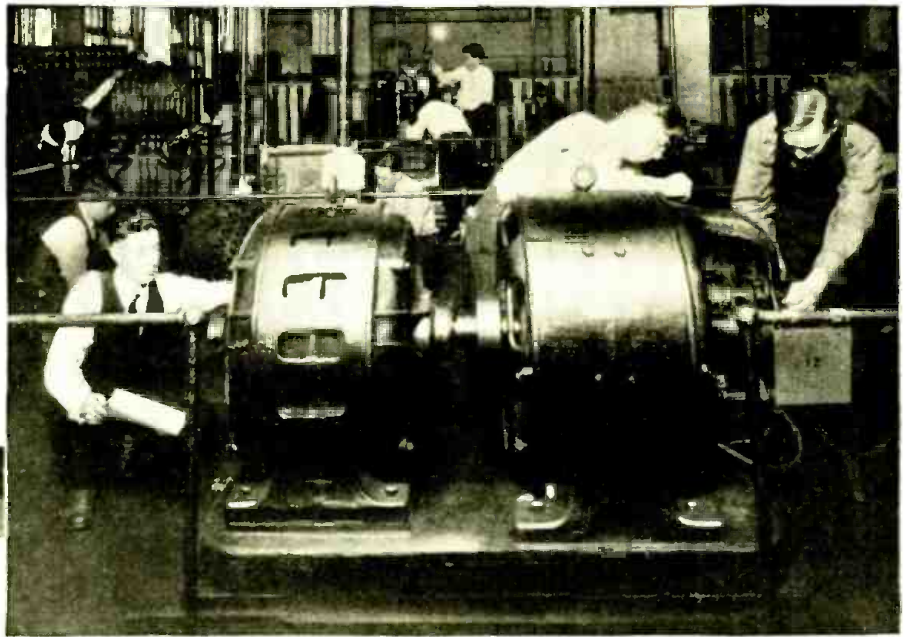

ELECTRICITY Becomes Amazingly Easy When Taught by Actual Shop Work ^{IN 90} _{DAYS}

Why work at dull, uninteresting jobs that will never pay you more than \$35, \$40 or perhaps \$50 a week? Make up your mind NOW and become a master of electricity! Train in 12 easy weeks to hold down the kind of a job that pays up to \$60 and more a week, and which creates a constant demand for your service nearly any place in the world!

Practical Shop Training

Electricity, as taught in the Great Shops of Coyne, is surprisingly easy to grasp. That's because we use no books. You learn by doing actual, practical experimenting on big, electrical machinery—finest outlay in the country. You learn by doing—and you learn from the ground up. No useless theory!

Not a CORRESPONDENCE SCHOOL

Experts work right along with you every step of the way. You get personal attention—you are trained by actual shop work on actual electrical machinery. The COYNE WAY gives you real, sound knowledge that fits you to do practical electrical work in all its branches.

Now in Our

NEW HOME --

This is our new, fireproof, modern home wherein is installed thousands of dollars' worth of the newest and most modern Electrical Equipment of all kinds. We have now the largest amount of floor space devoted to the exclusive teaching of practical electricity in the world. Every comfort and convenience has been arranged to make you happy and contented during your training.

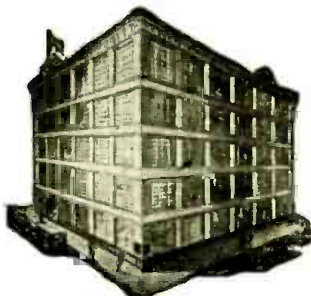

COYNE ELECTRICAL SCHOOL
H. C. LEWIS, Pres., Est. 1899
500 S. Paulina St., Dept. 81-81 Chicago, Ill.

NO EXPERIENCE or Advanced Education Necessary

You don't need one days' previous electrical experience or advanced education to master electricity the Coyne way. Some of our most successful graduates never went farther than the 8th grade.

Earn While You Learn

By special arrangement, our employment department helps students locate part-time work, if they want to earn while they learn. And after graduation we give them the benefit of our FREE EMPLOYMENT Service for Life. Every week we secure many positions for Coyne men.

Get FREE BOOK

Write today for my big book on Electricity with over 150 photographs. Learn what great opportunity Coyne Training opens up for you. Also get full details of my Big 3-Special Offer. No obligation. Mail the coupon now.

INCLUDED

If You Act Now!

- 1 BATTERY** Course, including construction, charging, etc., without one cent of extra cost to you.
 - 2 AVIATION** my big new Aviation Electrical course included at no extra charge.
 - 3 RADIO SERVICE** course included absolutely without any extra charge.
 - 4 AUTO** course, covering truck and tractor electricity.
- SEE COUPON!

FREE BOOK *Coupon*

H. C. LEWIS, President
COYNE ELECTRICAL SCHOOL, Dept. 81-81
500 S. Paulina Street, Chicago, Ill.

Please send me your free catalog on Electricity and details of your low tuition offer and extra courses. No obligation on my part.

Name

Address

City State

Pilot Achieves Radio's Greatest Sensation!

The Entire World of Radio

ON A SINGLE KNOB

15 TO 650 METERS NO COILS TO CHANGE

The New

PILOT

UNIVERSAL SUPER WASP RECEIVER

Partly assembled "Universal" for the man who likes to "roll his own". With walnut cabinet, less tubes and speaker.

85⁰⁰

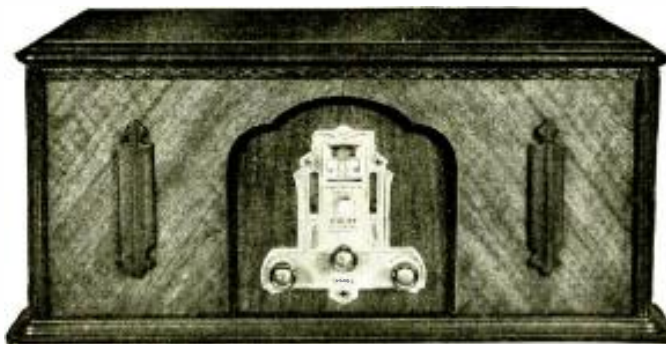

Pilot's wonderful wave band changing switch, incorporated in the new Universal Super-Wasp, revolutionizes the short wave art. No longer need numerous coils be changed to cover the various wave bands. No longer need dial settings change each time the same distant stations are tuned in. You can log permanently all the stations you can get throughout the world, you can tune from the short waves to the high ship waves without removing your hand from the single control knob.

Universal Features Revolutionizing the Short Wave Art

Complete coverage all wave bands from 15 to 650 meters *without coil changing*. Complete A.C. operated *chassis in cabinet*. (Also available in battery model) . . . All Metal Chassis

. . . Highly sensitive and selective circuit . . . Screen Grid TRF amplifier *plus* Screen Grid Detector . . . 227 First Audio Stage . . . Two 245's in push-pull output stage . . . Stations can be logged *permanently on dial* . . . Regeneration control does not alter tuning . . . Provision for *Phonograph Pick-up* . . . Earphone Jack on *Front Panel* . . . Illuminated Dials . . . Handsome Walnut Cabinet . . . Most advanced construction yet used for short wave work . . . In kit form for easy home assembly; no drilling or cutting, all parts fully prepared.

NOTICE TO "HAMS": Pilot will continue building the original Super-Wasp in kit form for licensed amateurs and others who want to spread the tuning on their pet wave bands and add their own audio features. A.C. and battery models.

PILOT RADIO & TUBE CORP., Lawrence, Mass.



Chicago: 234 S. Wells St.

New York: 525 Broadway

San Francisco: 1278 Mission Street

OFFICES IN PRINCIPAL COUNTRIES OF THE WORLD

BIG PAY JOBS

open

for the Radio Trained Man

Scores of jobs are open to the Trained Man—jobs as Designer, Inspector and Tester—as Radio Salesman and in Service and Installation work—as Operator, Mechanic or Manager of a Broadcasting station—as Wireless Operator on a Ship or Airplane—jobs with Talking Picture Theatres and Manufacturers of Sound Equipment—with Television Laboratories and Studios—fascinating jobs, offering unlimited opportunities to the Trained Man.

Ten Weeks of Shop Training

Come to Coyne in Chicago and prepare for these jobs the QUICK and PRACTICAL way—BY ACTUAL SHOP WORK ON ACTUAL RADIO EQUIPMENT. Some students finish the entire course in 8 weeks. The average time is only 10 weeks. But you can stay as long as you please, at no extra cost to you. No previous experience necessary.

TELEVISION *and* TALKING PICTURES

In addition to the most modern Radio equipment, we have installed in our shops a complete model Broadcasting Station, with sound-proof Studio and modern Transmitter with 1,000 watt tubes—the Jenkins Television Transmitter with dozens of home-type Tele-

vision receiving sets—and a complete Talking Picture installation for both “sound on film” and “sound on disk.” We have spared no expense in our effort to make your training as COMPLETE and PRACTICAL as possible.

FREE Employment Service to Students

After you have finished the course, we will do all we can to help you find the job you want. We employ three men on a full time basis whose sole job is to help our students in finding positions. And should you be a little short of funds, we'll gladly help you in finding part-time work while at school. Some of our students pay a large part of their living expenses in this way. Mail the coupon below!



COYNE IS 32 YEARS OLD

Coyne has been located right here in Chicago since 1899. Coyne Training is tested—proven by hundreds of successful graduates. You can get all the facts—FREE. JUST MAIL THE COUPON FOR A FREE COPY OF OUR BIG RADIO AND TELEVISION BOOK, telling all about jobs . . . salaries . . . opportunities. This does not obligate you. JUST MAIL THE COUPON!

RADIO COYNE ELECTRICAL SCHOOL
DIVISION H. C. LEWIS, President Founded 1899
50 S. Paulina St., Dept. 81-8H, Chicago, Ill.

H. C. LEWIS, President

Radio Division, Coyne Electrical School
500 S. Paulina St., Dept. 81-8H, Chicago, Ill.

Send me your Big Free Radio and Television Book. This does not obligate me in any way.

Name

Address

City..... State.....

FREE Supplements are mailed every 60 days to owners of the 1932 Official Radio Service Manual

FREE Questions and Answers Service

Schematic Diagrams of All Latest Midget Receivers

Expert servicing or installation of radio receivers requires that the dealer, service man or radiotrician be thoroughly experienced in handling sets of any manufacture. Needless to mention how important are modern methods of servicing, and how easy it is to complete any service job when the OFFICIAL RADIO SERVICE MANUAL is on hand. The NEW 1932 M.I.N.U.11. contains a Full Radio Service Guide and a most Complete Directory of all 1931-1932 Radio Receivers as well as models of older design. Everyone employed in the Radio Industry should have a copy available for his own use.

\$5.00

The Copy

HUGO GERNSBACK,
Editor

C. E. Denton
Managing Editor

Clyde Fitch,
Managing Editor



Partial Contents of the Manual

A step-by-step analysis in servicing a receiver which embodies in its design every possible combination of modern radio practice; it is fully illustrated and thoroughly explained. It is the greatest contribution to the radio service field.

Chart showing the operation of all types of vacuum tubes, whether new, old or obsolete. An exclusive resume of the uses of the Pentode and Variable Mu Tubes and their characteristics.

Complete discussion of the superheterodyne and its inherent peculiarities. Also a special chapter on tools used on superheterodyne circuits.

Schematic diagrams and circuits complete with color codings.

Important chapters on commercial aircraft radio equipment; new data on commercial short wave receivers and converters.

Servicing and installation of public address systems and talking machine equipment.

Standardized color codings for resistors.

Operation of old and new testing equipment; tube voltmeters, output meters, oscillators and aligning tools.

A full section on Midget radios—their design, circuits and types. How to service them most economically.

Hundreds of schematic diagrams of older radio receivers which have never been published.

Blank pages for recording notes, diagrams and sketches; these pages are transferable to any part of the book.

OVER 1,000 PAGES

Over 2,000 Diagrams, Charts and Illustrations

Flexible Loose Leaf Binder
9 x 12 Inches

Complete Directory of All 1931-1932 Radio Receivers
Full Radio Service Guide For Radio Service Men, Dealers, Jobbers, Manufacturers and Set Builders

Clip Coupon NOW!

GERNSBACK PUBLICATIONS, Inc., RC-11
96-98 Park Place, New York, N. Y.

I enclose herewith remittance of \$5.00, check or money order preferred, for which you are to send me the NEW 1932 OFFICIAL RADIO SERVICE MANUAL. I understand that all the New material will be included in the Manual and Supplements will be mailed FREE every 60 days.

Name

Address

CityState.....

I Will Show You Too How to Start a Spare Time or Full Time Radio Business of Your Own



J. E. SMITH, President
National Radio Institute

The man who has directed the Home-Study Training of more men for the Radio industry than any other man in America.

Here are a few examples
of the kind of money
I train "my boys" to make

Started with \$5 Now has Own Business

"I started in Radio with \$5. purchased a few necessary tools, circulated the business cards you gave me and business picked up to the point where my spare time earnings were my largest income. Now I am in business for myself. I have made a very profitable living in work that is play."—Howard Houston, 512 So. Sixth Street, Laramie, Wyo.

\$700 in 5 Months Spare Time

"Although I have had little time to devote to Radio my spare time earnings for five months after graduation were approximately \$700 on Radio, sales, service and repairs. I owe this extra money to your help during the time I studied and since graduation."—Charles W. Linsey, 537 Elati St., Denver, Colo.



\$7396 Business in 2 1/2 Months

"I have opened an exclusive Radio sales and repair shop. My receipts for September were \$2,332.16, for October \$2,887.77 and for the first half of November, \$2,176.32. My gross receipts for the two and one-half months I have been in business have been \$7,396.25. If I can net about 20% this will mean a profit of about \$1,500 to me."—John F. Kirk, Kirk Sales and Service, Union Block, Spencer, Iowa.

My Free book gives you many more letters of N. R. I. men who are making good in spare time or full time businesses of their own

Without Capital

THE world-wide use of receiving sets for home entertainment, and the lack of well-trained men to sell, install and service them have opened many splendid chances for spare time and full time businesses. You have already seen how the men and young men who got into the automobile, motion picture and other industries when they were young had the first chance at the key jobs—and are now the \$5,000, \$10,000 and \$15,000 a year men. Radio offers you the same chance that made men rich in those businesses. Its growth is opening hundreds of fine jobs every year, also opportunities almost everywhere for a profitable spare time or full time Radio business. "Rich Rewards in Radio" gives detailed information on these opportunities. It's FREE.

So many opportunities many make \$10 to \$25 a week extra while learning

Many of the ten million sets now in use are only 25% to 40% efficient. The day you enroll I will show you how to do 28 jobs common in most every neighborhood for extra money in your spare time. I will show you the plans and ideas that are making as high as \$200 to \$1,000 for others while taking my course. G. W. Page, 133 Pine St., McKenzie, Tenn., writes: "I made \$935 in my spare time while taking your course."

Many \$50, \$60 and \$75 a week jobs opening in Radio every year

Broadcasting stations use engineers, operators, station managers, and pay \$1,200 to \$5,000 a year. Radio manufacturers use testers, inspectors, foremen, engineers, service men and buyers for jobs paying up to \$7,500 a year. Shipping companies use hundreds of operators, give them world-wide travel and pay \$85 to \$150 a month, plus free board. Radio dealers and jobbers are continually on the lookout for good service men, salesmen, buyers, managers, and pay \$30 to \$100 a week. Talking Movies pay as much as \$75 to \$200 a week to the right men with Radio training. My book tells you of other opportunities in Television, Aircraft Radio and other fields.

I will train you at home in your spare time

Hold your job until you are ready for another. Give me only part of your spare time. You don't have to be a high school or college graduate. Hundreds have won bigger success. J. A. Vaughn jumped from \$35 to \$100 a week. E. E. Winborne seldom makes under \$100 a week now. The National Radio Institute is the Pioneer and World's Largest organization devoted exclusively to training men and young men, by correspondence for good jobs in the Radio industry.

You Must Be Satisfied

I will give you an agreement to refund every penny of your money if you are not satisfied with my Lessons and Instruction Service when you complete my course. And I'll not only give you thorough training in Radio principles, practical experience in building and servicing sets, but also Advanced Training in any one of five leading branches of Radio opportunities.

My 64-Page Book Gives the Facts

Clip and mail the coupon now for "Rich Rewards in Radio." It points out the money-making opportunities the growth of Radio has made for you. It tells of the opportunities for a spare time or full time Radio business of your own, the special training I give you that has made hundreds of other men successful; and also explains the many fine jobs for which my course trains you. Send the coupon to me today. You won't be obligated in the least.

Get
my new book
It points out
what Radio
Offers You



J. E. SMITH, President
Dept. 1 MXA
National Radio Institute
Washington, D. C.

You will get Extensive Practical Radio Experience with my Home Experimental Outfits



Rear view of 7 Tube Screen Grid Tuned Radio Frequency set—only one of the many circuits you can build with my outfits.

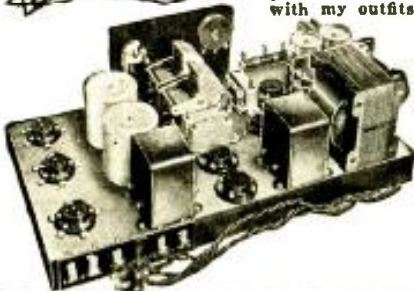

My course is not all theory. You use the 8 Outfits I'll give you, in working out the principles, diagrams and circuits used in modern sets and taught in my lesson books. This 50-50 method of home training makes learning easy, fascinating, interesting. You get as much practical set servicing experience in a few months as the average fellow who hasn't had this training gets in two to four years in the field. You can build over 100 circuits with these outfits. You experiment with and build the fundamental circuits used in such sets as Crosley, Atwater-Kent, Eveready, Majestic, Zenith, and many others sold today. You learn how these circuits work, why they work, how they should work, how to make them work when they are out of order.

THIS COUPON IS GOOD FOR ONE FREE COPY OF MY NEW BOOK

mail it TODAY

J. E. SMITH, President,
National Radio Institute, Dept. 1 MXA
Washington, D. C.

DEAR MR. SMITH:—Send me your book. I want to see what Radio offers. I understand this request does not obligate me and that no agent will call.

Name

Address

City State

Get the facts on my Lifetime Employment Service to all Graduates

**A Better TUBE*
KEEPS
A Customer
LONGER
Satisfied**



WHEN you speak about the replacement—you should talk PERRYMAN.* You as counsel to your customers must be backed by a tube of outstanding quality. PERRYMAN tubes meet the most exacting requirements and will build permanent good will and an ever increasing volume of sales for you.



Your stock should include a varied supply of PERRYMAN Tubes. Write Dept. RC for the name of nearest wholesale distributor; also our special proposition for service men.

PERRYMAN Tube production has increased steadily during the past few months to keep pace with the demand for new tubes. The new low list prices have been carefully adjusted to enable dealers and servicemen to make a fair profit—PERRYMAN Replacement Policy assures recommendation by others for new tubes.

PERRYMAN ELECTRIC CO.
INCORPORATED
NORTH BERGEN :: :: NEW JERSEY

PERRYMAN



RADIO TUBES

Why be satisfied with less than Round the World Reception?

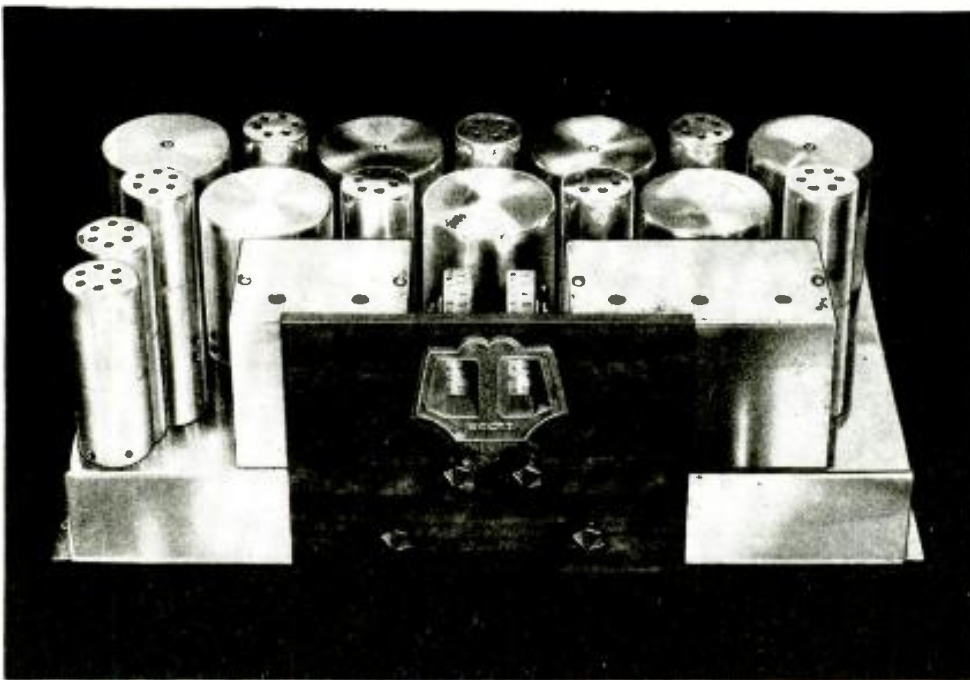

There is a new thrill in Radio—the thrill of actually tuning in the other side of the world—Japan, Indo-China, France, England, Australia, Germany and South America. Not code, but voice, music and song, loud and clear—often so perfect that its quality matches the finest nearby domestic stations. Such is the daily service being given by Scott All-Wave Receivers located in all parts of the country and operating under all sorts of conditions. And the tone of the Scott All-Wave is *naturalness* itself. Think of it! England and Japan, thousands of miles away from each other, yet only a quarter inch apart on the dial of the Scott All-Wave. A fractional turn of the tuning control and either is yours to listen to with an abundance of loud speaker volume. Unbelievable? Read the letters reproduced below. They are but a few of the hundreds received!

Read What Scott All-Wave Owners Say About This Great Receiver

England on an indoor aerial . . .

"London, England, comes in with great volume on an indoor aerial, which I have to use on account of static. Can get all the volume I want with the volume control turned up most of the time only one-quarter."

—W. J. McD., Intercare, N. H.

Round the world . . .

"I have heard 'Big Ben' strike midnight in London; Grand Opera from Rome; the 'Marschallaise' played in France and at 8:30 a. m. have heard the laughing lack-ass from VK2ME at Sydney, Australia."

—C. L. B., Chicago, Illinois

China, too . . .

"Static conditions have been extremely bad this Summer.

However, we have been getting regular reception on G5SW at Chelmsford, England, 12RO at Rome, Italy, F3CD, Indo-China, and VK3ME at Melbourne, Australia."

Paris for 3 hours . . .

"Yesterday I tuned in station FYA at Paris and received them for three hours with considerably more volume than Rome; El Prado, Ecuador, comes in very clear and loud every Thursday evening."

—S. O. K., Tuskegee, Alabama

Records Australia . . .

"Last Saturday night I received VK2ME, Sydney, Australia, loud enough to make a recording on my home recorder. It certainly gave me a great thrill to hear the announcer say, 'The time is now

20 minutes to 4, Sunday afternoon' when it was 20 minutes to 12 Saturday night here."

—J. R. C., Highland, Mass.

Germany to Australia . . .

"I hear England, France, Italy, daily while Ecuador, Colombia, Honduras and Germany and Manila come in quite often. VK2ME at Sydney, Australia, comes in very well."

—J. M. B., Wierton, West Virginia

Austria . . .

"I have tuned in VK3ME at Melbourne with enough volume to be heard across the street. I listened last evening to France, Italy, Austria, as well as G5SW in England and several other European stations. The SCOTT is all you claim and then some."

—R. N. B., Fullerton, Penna.

The truly amazing performance of which the Scott All-Wave is capable is the natural result of combining advanced design and precision engineering. The system of amplification employed in this receiver is far in advance of any other—and the Scott All-Wave is built in the laboratory, by laboratory experts to laboratory standards so that its advanced design is taken fullest advantage of. Each receiver is tested, before shipment, on reception from either 12RO, Rome, 5SGW, Chelmsford, England, or VK3ME, Melbourne, Australia.

Why be satisfied with less than a Scott All-Wave can give you? The price of this receiver is remarkably low. Mail the coupon for full particulars.

E. H. SCOTT RADIO LABORATORIES, INC., 4450 Ravenswood Ave., Dept. C-11 Chicago
(Formerly Scott Transformer Co.)

The SCOTT ALL-WAVE

15-550 METER SUPERHETERODYNE

Clip

E. H. SCOTT RADIO LABORATORIES, INC.

(Formerly Scott Transformer Co.)

4450 Ravenswood Ave., Dept. C-11 Chicago, Ill.

Send me full particulars of the Scott All-Wave.

Name

Street

Town State

RADIO

Manufacturers, Distributors, Jobbers *and* Dealers

If in need of Service Men wire or write us and we will send you the name and address of Service Men in your city or vicinity.

THIS SERVICE IS FREE TO THE RADIO TRADE.

OFFICIAL RADIO SERVICE MEN'S ASSOCIATION, Inc.

98 Park Place, New York, N. Y.

Radio Service Men—Join the ORSMA

EVER since the appearance of the commercial radio broadcast receiver as a household necessity, the Radio Service Man has been an essential factor in the radio trade; and, as the complexity of electrical and mechanical design in receivers increases, an ever-higher standard of qualifications in the Service Man becomes necessary.

The necessity, also, of a strong association of the technically-qualified radio Service Men of the country is forcing itself upon all who are familiar with radio trade problems; and their repeated urging that such an association must be formed has led us to undertake the work of its organization.

This is the fundamental purpose of the OFFICIAL RADIO SERVICE MEN'S ASSOCIATION, which is not a money-making institution, or organized for private profit; to unite, as a group with strong common interests, all well qualified Radio Service Men; to make it readily possible for them in keeping up with the demands of their profession; and, above all, to give them a recognized standing in that profession, and acknowledged as such by radio manufacturers, distributors and dealers.

To give Service Men such a standing, it is obviously necessary that they must prove themselves entitled to it; any Service

Man who can pass the examination necessary to demonstrate his qualifications will be elected as a member and a card will be issued to him under the seal of this Association, which will attest his ability and prove his identity.

The terms of the examination have been drawn up in co-operation with a group of the best-known radio manufacturers, as well as the foremost radio educational institutions.

We shall not attempt to grade the members into different classes. A candidate will be adjudged as either passing or not passing. If the school examining the papers passes the prospective member as satisfactory, we shall issue to him an identification card with his photograph.

If the candidate does not pass this examination the first time, he may apply for another examination three or six months later.

There is absolutely no cost attached to any service rendered by the Association to its members, no dues, no contributions.

If you wish to become a member, just fill out the coupon below and mail it to us. We will send you all the papers necessary to become a member.

The following firms have cooperated with us in formulating the examination papers.

The Crosley Radio Corporation, Cincinnati, O. Mr. D. J. Butler, Service Mgr.
Grigsby-Grunow Company (Majestic), Chicago, Ill. Mr. L. G. Wilkinson, Service Mgr.
Stromberg-Carlson Telephone Mfg. Co., Rochester, N. Y. Mr. E. S. Browning, Service Mgr.
Collin R. Kennedy, Corp., South Bend, Ind. Mr. B. F. McNamee, Prod. Mgr.
RCA-Victor Company, Inc., Camden, N. J. Mr. H. C. Grubb, Vice-President.
Stewart-Warner Corporation, Chicago, Ill. Mr. T. N. Golten, Service, Mgr.

The schools who have consented to act as an examination board are:

International Correspondence Schools, Scranton, Penna. Mr. D. E. Carpenter, Dean.
RCA Institutes, Inc., New York, N. Y.
East Bay Radio Institute, Oakland, Calif. Mr. T. T. Tonnehill, Director.
Radio Training Association of America, Chicago, Ill. Mr. A. G. Mohaupt, President.
School of Engineering of Milwaukee, Milwaukee, Wis. Mr. W. Werwath, President.
Radio College of Canada, Toronto, Canada. Mr. J. C. Wilson, Pre-Ident.
Radio Division, Coyne Electrical School, Chicago, Ill. Mr. H. C. Lewis, President.

MAIL COUPON TODAY!

OFFICIAL RADIO SERVICE MEN'S ASSOCIATION, Inc.		RC-11
98 Park Place, New York, N. Y.		
I wish to become a member of your Association. Please mail me the examination papers and application blanks.		
Name		
Address		
Town.....	State.....	

AMAZING World Wide Aero Short Wave Receiver

Listen in Direct to LONDON PARIS BERLIN BUENOS AIRES

Aero Short-Wave Converter



Convert your AC or DC radio set into a short-wave Superheterodyne. With this converter on your regular set you will be able to tune in short-wave stations from all different parts of the world. The Aero converter contains its own filament supply. B voltage can easily be obtained from your regular set, or you may use a single 45-volt B battery. No plug-in coils. Single tuning dial. Very easy to tune. No whistles or squeals. Uses two 1X227 tubes, one as oscillator and one as mixer. Price, AC model, less tubes, ready for operation, \$12.50. DC model for battery-operated sets, \$11.50. Two matched 1X227 tubes at 75c each, \$1.50; one 45-volt battery, \$1.45.

\$12.50

Only \$6.45



NEW AERO MIDGET

Using the Latest-Type PENTODE and MULTI-MU Tubes



Price, \$16.50. Here is a midget radio that everyone can afford, that has performance, distance and tone qualities like the larger and much more expensive sets. Wonderful tone quality and selectivity. Full dynamic speaker. Full vision dial. Phonograph pick-up plug. Beautiful walnut finish cabinet. This is a 5-tube set and sells for \$16.50. Price of complete set of 5 tubes is \$6.00.

ASTOUNDING . . . AUTO RADIO BARGAIN



This is the latest model 6-Tube Aero Pentode Auto Radio. Due to the use of the latest Pentode tubes, this set is equal in performance, to many 8-tube receiving sets. The circuit used is one which will be embodied in most of the expensive 1932 model auto radios. The complete set can be clamped on the steering post of your car, or can be operated by remote control from the dashboard. Price of set only \$20.00. The set complete with tubes, batteries, dynamic speaker, antenna equipment and noise suppressors, \$39.50.

Send for Latest Catalog of Parts and Equipment

CHAS. HOODWIN CO.

4240 Lincoln Avenue

Dept. L-150

Chicago, Ill.

A new radio thrill for you. Span the world with this set. Enjoy unique foreign programs from strange lands. Hear broadcasting stations from all over the world, via short waves. Your ordinary receiver cannot tune in these low-wave stations. World-wide receiver gets 14 to 550-meter stations with surprising clarity. Price of set, including 6 coils, \$6.45; price in foreign countries, \$7.75, postpaid.

CHAS. HOODWIN CO., Dept. L-150
4240 Lincoln Avenue,
Chicago, Ill.

You may send me the items I am filling in in the space below. Enclosed is my remittance to cover. It is understood that you guarantee your merchandise to be in first-class condition when delivered. (If cash is sent with order you may deduct 5% from the amount of your purchase. Should you order C.O.D. a deposit of \$1.00 is required on the short-wave receiver or short wave converter. A deposit of \$5.00 is required on the Aero Midget or Auto Radio.)

Items Wanted.....
Name.....
Street and No.....
City..... State.....

Build Your CUSTOMERS THE Revolutionary STENODE



STENODE selectivity curve makes 10KC selectivity, so-called, look like broad tuning.

STENODE selectivity is compared, at left, to that of ordinary receivers. All background noise is contained in outer curve. Stenode's curve, shaded, contains but 1-10 the total noise.



STENOTUBE. Only one required in each Stenode. This heart of the Stenode circuit consists of a quartz crystal ground to 175KC frequency and mounted in tube form for easy handling. Standard UX socket base. Price \$15.

Made in England

None genuine without the inventor's signature.

James Robinson

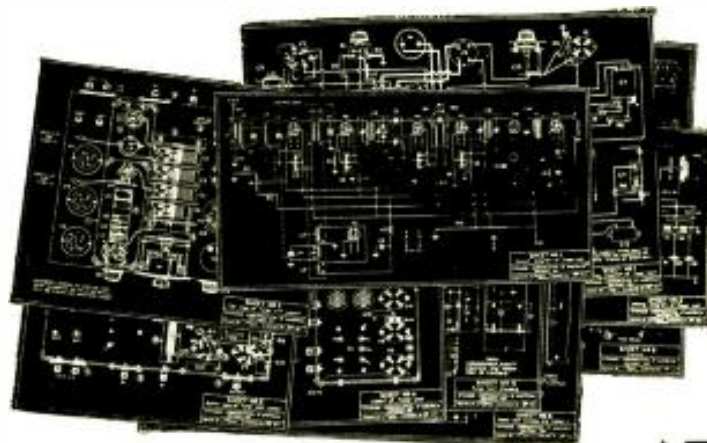

The Receiver That Is **NOISE FREE** on **SHORT WAVES** or **BROADCAST**

A STENODE demonstration will create more new custom set prospects than any radio receiver ever did before. People listen in amazement when they hear stations free of background noises and absolute silence between stations. When you tune out heterodynes and whistles and stations STAY IN strong and crystal clear, owners of all other sets gasp in astonishment. The former chief of wireless research of the British Royal Air Force, Dr. James Robinson has given an entirely new principal to radio in STENODE.

By the STENODE principal the highest selectivity ever attained as well as unprecedented tonal range is now made possible. All engineers agree that it is impossible with ordinary superheterodynes.

STENODE amplifies signals most and static least. That's why YOU want to build an 11 tube STENODE to work with a SHORT WAVE adapter when it is not used to log and listen with enjoyment to more broadcasters than can be heard on any other type of radio. STENODE selectivity is 5 to 1 greater than that of so called 10KC Supers. The noise does not get in along with the high audio frequencies, and the STENODE reproduces perfectly higher frequencies than ever heard on any other receiver giving

500% BETTER SELECTIVITY
1000% MORE FREEDOM FROM NOISE
INFINITELY BETTER QUALITY

9 Blue Prints - Data Book - Direction Book Now \$5

Increased demand for Stenode Data Book, Instruction Book and Blue Prints permits our cutting former price in half. Those who have already sent in full price will receive our check for \$5. We are not interested in making profit from our engineering service. Our profits come solely from Royalties paid us by our licensees.

STENODE CORP. OF AMERICA
Hempstead Gardens, L. I., N. Y.

11-11

Enclosed find Money Order, Check, for \$..... Please forward me STENOTUBE, BLUE PRINTS, DATA BOOK and DIRECTION BOOK for building STENODE.

Name

Street

City State

The STENODE opens up new fields for short-wave and television work, as well as broadcasting. Full details of all sorts of applications are given in the STENODE Data Book. Nine full-sized diagrams show where to place every part. How to make every connection is clearly told in STENODE Book of Directions. Your finished STENODE will put you into a new field of radio. Fill in and mail the coupon with your money order for the biggest value ever offered custom set builders.

STENODE CORP. OF AMERICA
HEMPSTEAD GARDENS, L. I., N. Y.
(FORMERLY AMERICAN RADIOSTAT CORP.)

IF IT ISN'T A STENODE IT ISN'T A MODERN RECEIVER



“Takes the Resistance Out of Radio”

Editorial Offices, 96-98 Park Place, New York, N. Y.

Extra Money For Service Men

By HUGO GERNSBACK

THERE are some Service Men—and their number is increasing rapidly—who seem to feel that there is very little money left in the radio servicing game.

Nothing could be more erroneous; and it may be safely said that the Service Men who voice these sentiments are not only still in the minority, but certainly, they do not use up-to-date and aggressive service methods mixed with a goodly amount of gray matter.

Radio dollars do not tend to grow on trees. You have to go and look for them, exactly as for any other kind of dollars. When times are difficult, like the present, and people do not spend as freely as of yore, a certain amount of ingenuity is needed in order to get extra sales. For that reason, the up-to-date Service Man these days does not content himself with just servicing sets, which is his trade. Of course, if there are enough sets to be serviced, it is certain that the Service Man will find no cause for complaint. If, on the other hand, he has a limited clientele, whose sets do not happen to require servicing, there is still a good deal of money to be made from extra efforts which have nothing to do with servicing itself, strictly speaking.

When things are dull, the radio Service Man can easily become a radio salesman and supply his customers with all sorts of radio merchandise; and, if you once have an entree to the customer, it is usually an easy matter to “sell” your prospect.

Most of the sets made prior to 1931 contained no Pentodes. It should not be difficult to convince a set owner of the better quality, greater volume, etc., that can be had through the use of the new Pentodes. It is no trick at all, with most sets, to change them over from the old-type tubes to Pentodes at a decent profit to the Service Man. Most set owners, these days, cannot afford to get new sets; but they welcome having their sets brought up to date, if it can be done.

In this issue there is described a new “Tune-A-Lite,” also known under the trade name of “Flashograph.” This new tuning device is an elongated neon tube, which is already built into several 1932 sets. The main idea is that the neon bulb flashes to the highest point when the set is in resonance with a certain station. This is a brand new device that is sure to interest the average set owner. During the next few months, it will be possible to buy a complete Tune-A-Lite section that can be attached to the outside of the radio set, and it will also be possible, with a little cabinet work, to fit one into a present-day set. A demonstration of such a light is sure to make a sale.

I have spoken before of short-wave adapters. Now-a-days, people wish to tune in foreign countries direct, and get the thrill of hearing the European and other world broadcasts that

fill the air. A large amount of such adapters are already to be had, listing from low prices up to the more expensive models. If the Service Man carries one of these adapters with him, and shows the owner how comparatively simple it is to tune in a foreign program, the sale can easily be made.

Electric (A.C.) clocks are becoming the rage all over the country. They are not only cheap, but they keep time most accurately. The consumption of current is almost nil. An ideal position for such a clock is on top of a radio set; and many Service Men are making slight structural changes in existing cabinets, to fit electric clocks into the standard receivers. A sample of the clock, carried around and demonstrated, will frequently result in a sale.

Then, of course, tone controls, of which many can be had, and at reasonable prices, are still good sellers. They take but a few minutes to install; and a simple demonstration to your prospect nearly always results in a sale. There seems to be a certain reluctance, in most people, when it comes to listening to lectures and talks over the radio. In most sets not equipped with tone controls, the talk is usually sharp and “brilliant.” This the tone control can “mellow down,” and thus make the talk far more agreeable to the individual taste. One Service Man reports that four out of five demonstrations result in sales.

The itch for distance seems to be on the increase, even on the long-wave broadcast set. For a time, most people wished only to get local programs; now it seems they are hunting for distant stations again, if the many letters that we receive are a true indication of this. As a rule, successful “DX” (long-distance) reception pre-supposes a good aerial. A large proportion of present aerials were installed in a hurry, and are not good in the electrical sense. Set owners who use indoor aerials, and light-socket connector aerials, should be sold on the idea that their set will give them far greater volume if a good hundred-foot outdoor aerial—providing there is sufficient room—is installed.

Then, there is, of course, a tremendous market for line-noise filters. Radio set owners who live in apartment houses, if they have a sensitive set, know that they will get a click every time a light is switched on in the house. Then there are disturbances from refrigerators, vacuum cleaners and a host of other appliances. There are now on the market a number of efficient noise filters, and an up-to-date Service Man should always carry a few with him. Once the prospect understands what it is all about, he will not hesitate to spend a few dollars if he knows that his reception will be relieved of a great deal of man-made static.

I have only sketched a few of the more obvious ways in which the Service Man can pick up dollars right and left, if he only goes after them. There are, of course, many other methods which he will find if he uses his head.

Television Aids The Blind

How an ultra-modern use of television components, principally the "PE" cell and scanning disc, enables the blind figuratively to "see"

WRITERS of scientific fiction for some years, discussed the possibility of creating a robot which would look on the printed page, and read it aloud. With our present art of writing, and haphazard method of pronunciation, we may consider this to be practically impossible. With an absolutely phonetic language, certain characters would convey certain sounds; but the pitch and stress of the voice are not indicated in printing, and even with a phonetic alphabet the voice of the robot would be unendurably monotonous.

However, there are those who are unable to read printing of the ordinary kind, no matter how good their education—the blind. For their benefit, books have been translated or transcribed into "Braille." This indicates a method of embossing letters from beneath into the paper, so that the delicate fingers of the sightless can determine their form, and thus translate them into sensory impulses.

Since the demand for books for the blind is small, most works of this nature are produced one at a time, by hand, as the old manuscripts were copied, except that a punching machine comparable to a typewriter is used. There are in the New York Public Library about five thousand volumes, in various types of raised printing for the blind. These, however, being necessarily bulky, because of the thickness of the impressed sheets, and the fact that the letters must be large enough to be felt quickly with the finger tips, contain a comparatively small amount of text as compared with printed books.

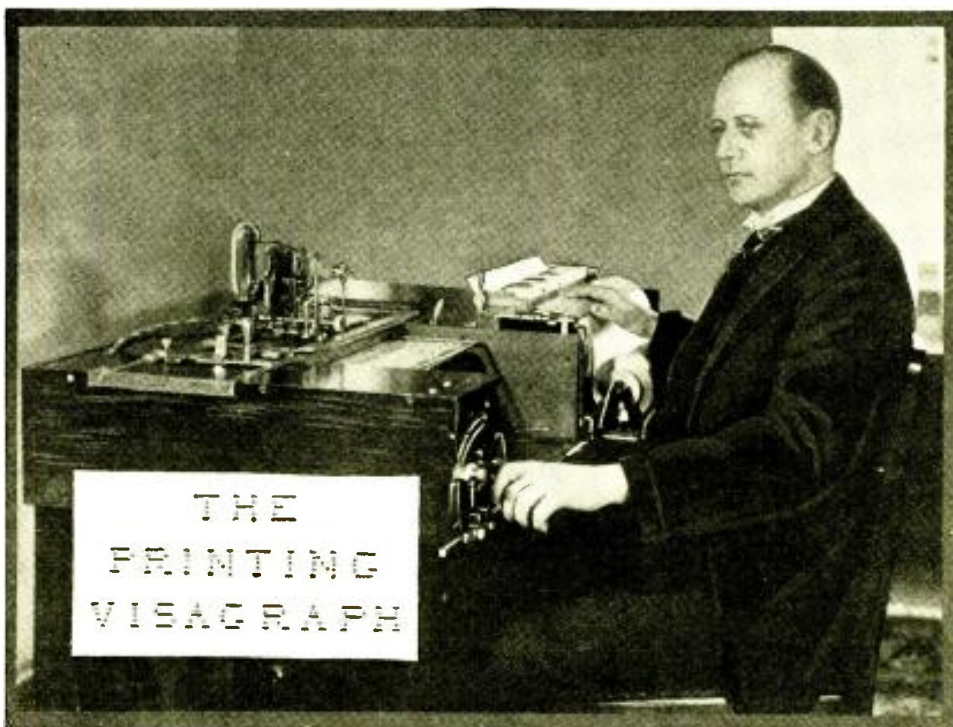

Fig. A
The printing Visagraph in action. The operator is manipulating the apparatus with one hand, while the other is "reading" a manuscript.

The idea of applying the principles of television to produce a reading machine, or rather an automatic transcribing machine, for the blind occurred to an inventor, Robert E. Naumburg, and resulted in the production of the remarkably ingenious device, the Visagraph, which is illustrated here in Fig. A.

While the method might be applied very easily to the production of sounds, their meaning must be very conventional, in view of the irregular spelling of words in all languages—unless perhaps Esperanto. It would be impossible to relate them to spoken English, French, etc.

The Visagraph attains its end by perforating a magnified image of the letters over which it passes its electric eye, in a sheet of paper, cardboard or thin aluminum. A sample of the work is reproduced in insert, Fig. A, in which, however, the raised letters have been blackened so that they may be visible. The sheet, however, is itself plain in color, as it is meant to be read by touch, not sight.

From the specimen of Braille letters, Fig. 1, it will be observed that their shape is conventional. The Visagraph, however, preserves the outline of the letters which it copies from the printed page.

For many purposes, a copying machine is used which transfers a pattern mechanically from one surface to another, either enlarged, fac-simile or reduced.

However, ordinary printing leaves practically no impression upon the surface of the paper; it is therefore necessary to "feel" for the characters with a photoelectric cell.

Since it is necessary to produce the letter bit by bit—the photoelectric cell recognizes

area of illumination, but not shape, a scanning disc is used, somewhat similar in principle to that used in television, only smaller in size. This has six rows of holes which, it will be noted, correspond to the six rows of long and short impressions which make up the letters of the insert, Fig. A.

Full details of the machine are not released by its inventor, but from the diagram (Fig. 2) and the result obtained, the general method can be determined. When a black area passes between the light-source (lamp) and the photoelectric cell, it intercepts the light, and the impulse (passed through the amplifier) is applied to the tuned circuit which corresponds to the particular row of holes in which the scanning ray is intercepted. This operates the relay, and a stylus, resembling that used in Braille writing is forced from beneath against the paper or metal on which the record is being

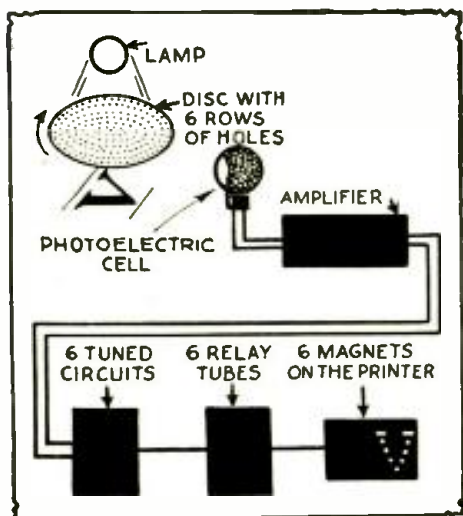

Fig. 2
The letter (V) is scanned by the disc. The reflected rays striking the "PE" cell are amplified and actuate a stylus which embosses the letter in aluminum foil.

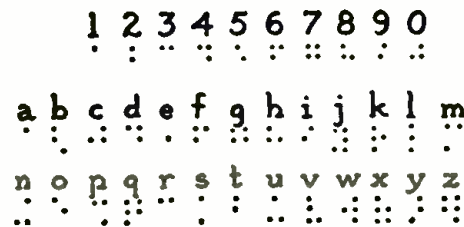

Fig. 1
An example of "American Braille." The arrangement of the dots constitutes the letter.

copied. This forces up the upper surface, and produces the impression. Five lines, it will be observed, form a letter 1/3-inch high; while a sixth is, presumably, reserved for the "descenders" or parts of letters

(Continued on page 301)

“Half-Wave Mast Antenna”

A 665-ft. Steel Structure Which Constitutes a New Departure



Fig. A
The mast antenna and the transmitter house.

A LONG one bank of the Pequannock River, in Wayne Township, at a point near Paterson, N. J., rises a majestic structure toward which the eyes of the engineering world are turning. In general appearance, it differs but little from most previous forms of radio “masts.” Its novelty, however, lies in the fact that this semi-self-supporting, 665-ft. structure is the antenna of the transmitter; which technically is called a “half-wave mast-antenna,” Fig. A.

This “mast-antenna” (a new term in radio) is part of the new 50,000-watt transmitter which is designed to supplant, except for emergency use, the old one of station WABC; and is a new type of broadcast aerial construction which breaks away from tradition, and establishes a precedent.

The bank of the river is about 1,000 feet from the development, but its bed extends inland at this point, so that the river flows underneath the station, six feet below the surface of the ground (in spots this is quicksand, and made construction extremely difficult).

An investigation of the rise of the Pequannock River for the past 50 years showed that the maximum level attained during this period was about six feet. In view of this, the “transmitter building” was constructed on a huge mat of steel and concrete, the first six feet of the building above ground being waterproofed. If the level of the river ever should rise to the six-foot mark, the building could be approached only by means of a row-boat, although the station would function as usual.

The single mast, shown in the illustration, is the antenna proper, and is tuned to one-half the wavelength of the station, which operates on a wavelength of 318.6 meters, or 860 kc.

The mast is constructed of specially treated steel, the joints being fastened by means of galvanized nuts and bolts (es-

pecially designed for the purpose). There are four guy wires (broken up by strain insulators, of which there are 28—seven to each guy wire); one end of each being fastened to the mast at a point 250 feet above the ground, and the other anchored 315 feet from the base of the mast.

Eight feet from the ground the mast terminates in a large porcelain “socket,” 12 feet across, that fits over the 8-foot ball-shaped top of a big porcelain base, which is imbedded in a concrete foundation—thus it is seen that a socket-and-ball mounting permits the mast during high winds to “give” in any direction, without straining the base mounting, Fig. 1.

Current leakage to ground during wet weather is kept to a low value due to the shape of the porcelain base, which is designed to have a long leakage path, and to the fact that the potential between the base of the antenna and ground is very low, thus greatly reducing the tendency toward leakage.

Since this tower compares in height with the Woolworth Building, it may have oc-

phone lines terminate at the “speech input” room, where the program is monitored, and then fed to the modulator tubes.

From the “transmission house,” (40 feet high), the 50,000 watt output is carried by a two-wire transmission line, on 15-foot poles, to the little 12-foot “coupling house,” which is only five feet from the mast; in Fig. A, it is shown nesting close to the base of the mast-antenna. A single, heavy lead runs from the “coupling house” to the base end of the mast-antenna.

As is well known, every antenna radiates both a “sky” wave and a “ground” wave. The sky wave travels upward at an angle until it reaches an ionized layer called the “Heaviside layer,” when the sky wave is reflected and refracted, returning to earth at some distant point; it is this wave that accounts for the long distance transmission of some stations. The ground wave, on the other hand, travels close to the ground, and it is this wave that supplies the energy for local reception. Therefore, the more energy we can get into the ground wave, the more stable will be local reception.

The novel WABC mast-antenna solves this problem by concentrating most of the energy in the ground wave, thus minimizing the possibility of fading within the most desirable, or “service” area, Fig. 2.

Still another feature of this type of radiator lies in its directional qualities. The usual “L” antenna radiates more energy in one direction than in another, while the energy distribution by the mast-antenna is approximately the same in all directions.

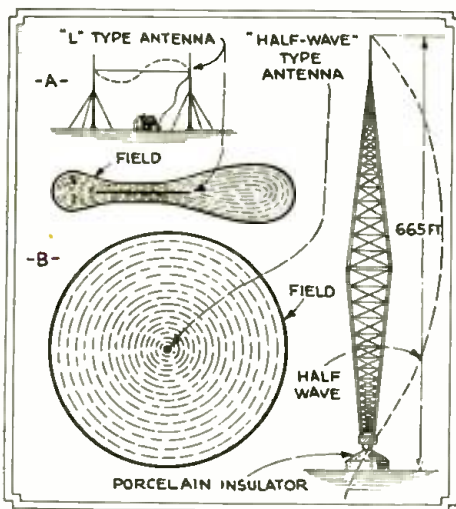

Fig. 2

The “service area” obtained when using a horizontal antenna, A; and a vertical antenna, B.

curring to the technician that the structure presents a hazard to plane aviation. However, this possibility was one of the first factors to be considered in the design, the result being that the mast-antenna, the buildings, and the entire surrounding acreage, are flood-lighted.

Going back now to the remote studio, we find that long-lines connections carry the program over wires run above-ground to within 1,000 feet of the “transmission house,” the intervening distance being traversed through underground cable; a precautionary shielding measure which prevents pick-up of the powerful electrostatic and electromagnetic fields surrounding the mast-antenna when it is in operation. The tele-

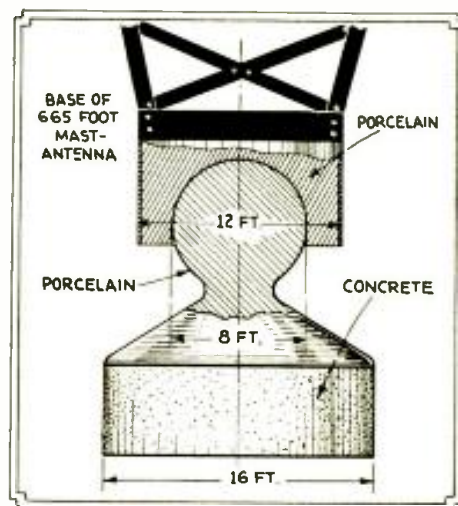

Fig. 1

At the base of the mast. One reason for small leakage is the long path from the base-to-ground length.

The new WABC installation is expected to be in operation in a short time, with a 24-hour watch. Technicians are awaiting with great interest the reports of reception from the new WABC “lower aerial.”

The Dynamic Microphone

An interesting description of a new Western Electric unit

By LOUIS MARTIN

MANY experimenters have, in the past, conceived the idea of using the loud speaker, of either the magnetic (moving iron) or dynamic (moving coil) type, as a telephone transmitter or "microphone." Even Alexander Graham Bell after developing the telephone receiver (the forerunner of our present-day magnetic loudspeaker), in 1877, experimented with it as a transmitter, or magnetic microphone.

Reviewing the successive steps in their development we find that the loudspeaker has outstripped the microphone in general efficiency, due mainly to the use of the "dynamic" principle of operation, in that a "moving coil" actuated by voice frequencies is arranged to float in a magnetic field (which, if produced by a field-coil designates the device as an electro-dynamic loudspeaker; or, where permanent magnets are used instead, a magneto-dynamic loudspeaker).

Although we have known all these years of the reversibility of the moving iron mechanisms, and the many advantages of a moving coil type of construction, it remained

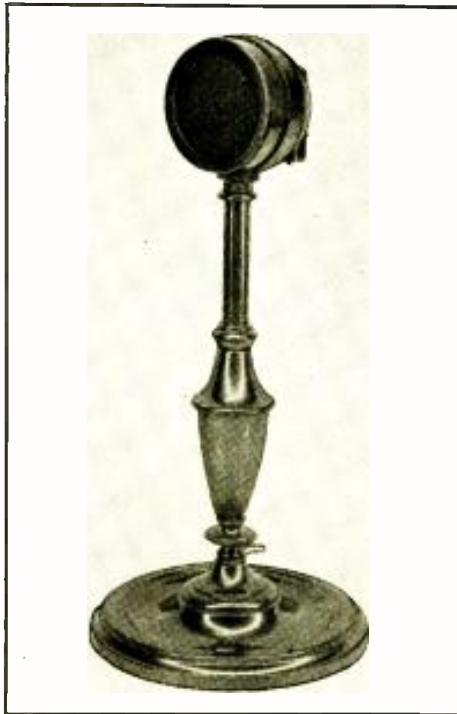

Fig. A

The Dynamic Microphone mounted in the "announcer"-type stand.

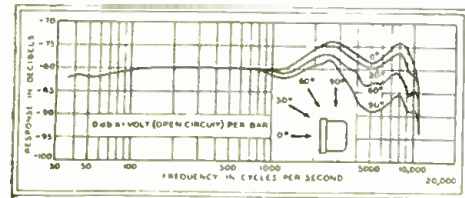

Fig. 3

Curves of response versus angles of incidence of sound.

for the Bell Telephone Laboratories to design a high-efficiency magneto-dynamic instrument, manufactured by the Western Electric Company, that adds a new word to radio terminology, namely, the "Moving Coil Microphone," Fig. A.

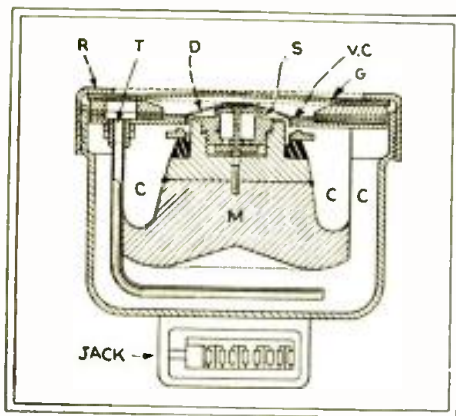

Fig. 1

Cross-section of the Dynamic Microphone, in which the letters have the following meanings: R, clamping ring; T, pressure-equalizing tube; D, diaphragm; S, air gap; V.C., voice-coil; G, protective grille; M, permanent magnet; C, cavities.

Types of Microphones

The microphone has advanced to its highest state of perfection in its "carbon" type, since it is capable of relatively high energy output (—36 DB), and is fairly sensitive and rugged; and yet, this instrument possesses the following disadvantages: First, its frequency response is not sufficiently good for real high quality broadcast transmission; second, the use of an energizing battery is necessary to secure reasonable sensitivity, and; third, the carbon granules weld or "pack," making the operation of the microphone extremely erratic.

The announcement of the "condenser" microphone, (consisting of two parallel plates, one of which is movable with respect to the other), with its excellent frequency response characteristic, was a boon to high quality reproduction. Still, although undoubtedly one of the best that can be secured, it has several physical disadvantages which materially limit its use. In the first place, its high impedance necessitates the use of a high voltage exciting battery, connected to it through a resistor of high value. The battery in itself is not only an inconvenience, but its associated microphone unit and resistor form a high-impedance line which absolutely requires that an amplifier be located within a few inches of the assembly; of course, this amplifier must have its quota of batteries and cables.

To eliminate the above-mentioned difficulties (or at least minimize them) has been

the aim of almost every acoustical engineering laboratory; and the outgrowth of a long series of experiments, the purpose of which was to design a microphone that would retain all of the excellent features of the condenser type, and at the same time remove its limitations, is the new Western Electric Type 618-A "moving coil" microphone shown in the photograph.

The Magneto-Dynamic "Mike"

Essentially it is composed of a diaphragm A supporting a voice-coil VC of fine aluminum ribbon, wound *edgewise* in the field of a permanent magnet M, as shown in the cross-section view, Fig. 1. When sound waves impinge on the diaphragm, the coil (to which it is rigidly attached) vibrates with a plunger-like motion, cutting the lines of force, and thus generating across two terminals a potential which is substantially constant from about 35 to 10,000 cycles. The use of the permanent magnet obviates the necessity of utilizing any exciting batteries; and since the impedance of the voice coil is only 25 ohms, that of the line load also is low. These factors combine to eliminate the batteries and the local amplifier.

The diaphragm A, is made of duralumin .001-in. thick, and has a dome-shaped center portion which extends to the inner edge of the moving coil. This type of construction stiffens the center so that the diaphragm has a plunger action throughout the entire audio-frequency range.

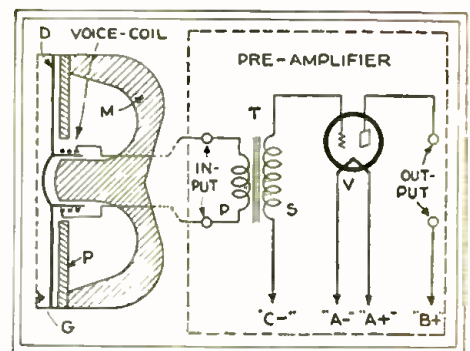

Fig. 2

Circuit for Type 618-A microphone and remote pre-amplifier (not always needed). Transformer T matches the "mike," and tube V.

The moving coil VC consists of about 65 turns of aluminum ribbon, .001-in. thick and .008-in. wide, edgewise wound; the turns are insulated with phenol varnish which serves also as a binder for holding together the adjacent turns. The coil is fastened to the diaphragm with spar varnish which is baked at a temperature sufficiently high to drive off any of the volatile matter that may be present. This insures a rigid bond between the adjoining surfaces.

Clamping of the diaphragm to the periphery of the housing is effected by the use
(Continued on page 301)

“PERMEABILITY TUNING”

200 to 550 Meters Without the Use of Variable Condensers

An amazing method of tuning without recourse to variable condensers. Wide-awake Service Men, set builders, and experimenters will acquaint themselves with the fundamental facts concerning this new development in radio receiver design.

By R. D. WASHBURNE



Fig. A
The Permeability Tuner.

THE radio public have, in the past, been deluged with propaganda tending to create the impression that this or that idea is one of the outstanding achievements of modern science. As a result, the public has become pessimistic regarding the practical outlook of such speculative advances—and justly so. In presenting this discussion on “permeability tuning,” RADIO-CRAFT does not imply that it is radically new, but rather that it represents a very decided advancement in the design of modern radio receivers. The use of condensers as a means of tuning has been utilized for such a long period of time, that it becomes difficult to think of tuning without the use of them.

Should this method of tuning ever become universally adopted, we may expect increased efficiency in ganging tuning controls, increased compactness, higher gain, hand-selection tuning and the elimination of that very troublesome device—the variable condenser.

R.F. coil; for instance, by winding and unwinding wire on a tube—one of the first “tuners” consisted of two tubes, one an in-

ductor and the other a conductor, the unused portion of the tuner wire (which was here) being shorted out of action by winding it onto the conductive tube, as shown at A, Fig. 1; also, by tapping the coil (using for this purpose a tap-switch or a slider), as shown at B in the same figure (an expedient in controlling the tuning range is to shunt across the inductance a fixed condenser C1).

By reversing, as shown at C, the operation illustrated at B—that is, replacing the variable inductance and fixed capacity, by a fixed inductance and variable capacity, L2 and C2, respectively, we arrive at the manufacturers’ idea of good receiver design.

Among the many intermediate stages of development, we must not forget the old Electro Importing Company’s collapsible helix construction, shown at D, in Fig. 1: (Continued on page 299)

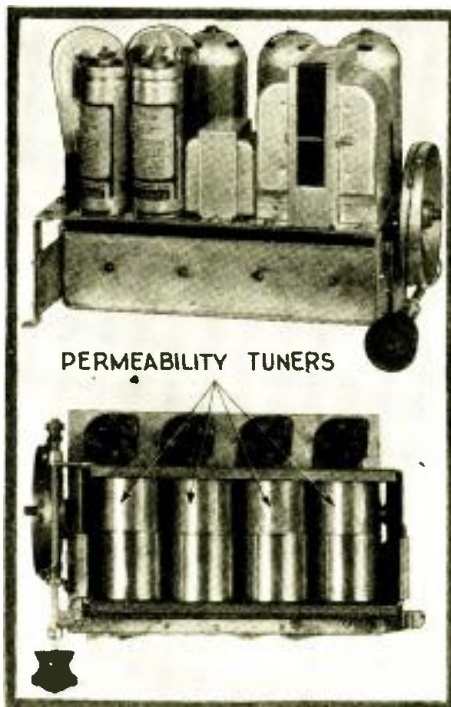

Fig. C
A perfected laboratory receiver.

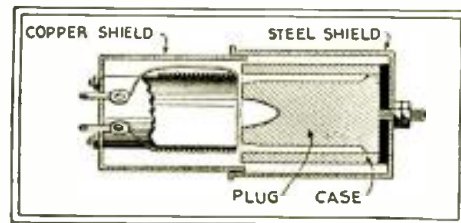

Fig. 4
Cross-section of an assembled tuner.

DERE-ROOTED in most of us is the idea that variable condensers; or, at least, a variometer construction, is absolutely necessary (but for a few well-known exceptions) in order to tune a radio receiver. Therefore, it comes somewhat as a shock to find that we must re-vamp all our old ideas, and look forward to the appearance of radio sets which, without benefit of variable condensers or interleaving coils, tune over the 200- to 550-meter band by changing the inductance of a coil through variation of its “permeability.” The completed instrument, illustrated in Fig. A, is the “Permeability Tuner” which crowns the laboratory work of Mr. W. J. Polydoroff of Chicago.

Of course, the fundamental system for changing the resonant frequency of a tuning circuit (in simple words, “tuning-in”) was to vary the number of active turns in an

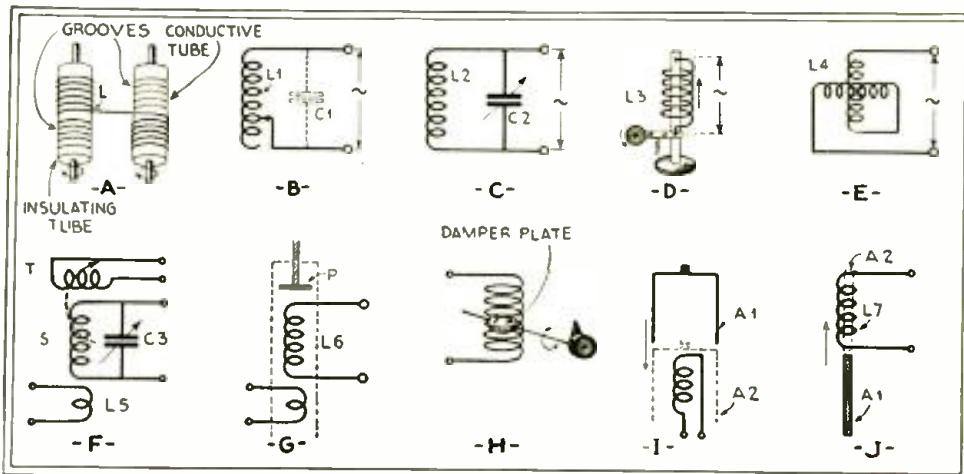

FIG. 1 Various methods of “tuning” a radio receiver. “Permeability tuning” is obtained if a magnetic material is adjusted with respect to the coil of wire, an example of the principle is J.

The NEWEST and MOST IN-

The latest radio equipment is described here for

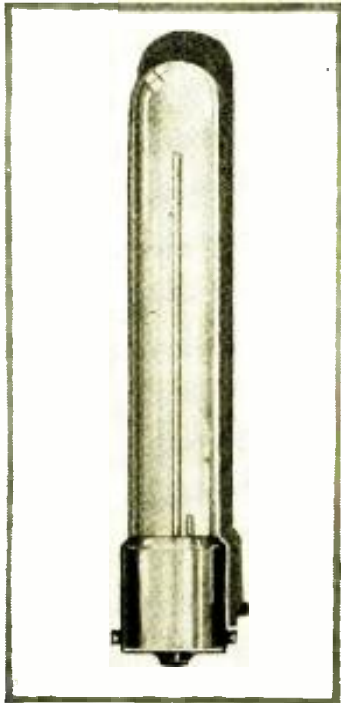

Fig. A
The neon station indicator.

neon resonance indicator
flashograph (neon V.I.) pentode radio
improved screen-grid automotive set
superheterodyne-type condenser gang
new radio service tools
caesium-type photoelectric cells
battery-powered superheterodyne
pentode-receiver power transformer
combination line- and volume-control

headlight socket; it measures 3½ in. high and ½ in. in diameter. Internally, the tube has two elements; a long *cathode* 3 3/16 in. in length, and a short *anode* ½-in. in length. The space is filled with *neon* gas.

Resonance in Height of Neon

As the voltage across any gas tube is increased from zero, a particular value of

WITH the increasing complexity of radio receivers, various methods have been used by set manufacturers to facilitate the tuning-in of broadcast stations. Milliammeters connected in the plate circuits of the detector or amplifying tubes, and gas-filled bulbs connected across the loud speaker terminals, have been successfully used in the past. A new device, known as the "Tune-A-Lite," Fig. A, has recently been announced, whose principle of operation and method of connection have aroused considerable interest of late.

Meters connected in the plate circuit of tubes, for the purpose of indicating when a station has been tuned to resonance, possess a few undesirable features. Gas lamps connected across the loud speaker terminals, while instantaneous in responding to changes in signal strength, indicate by varying their *intensity* of illumination.

The "Tune-A-Lite," described herein, incorporates all of the advantages of the gas-filled tube and at the same time indicates changes in volume by the *varying height* of a column of red neon light.

As shown in the illustration, Fig. A, this new tube mounts in an ordinary automobile

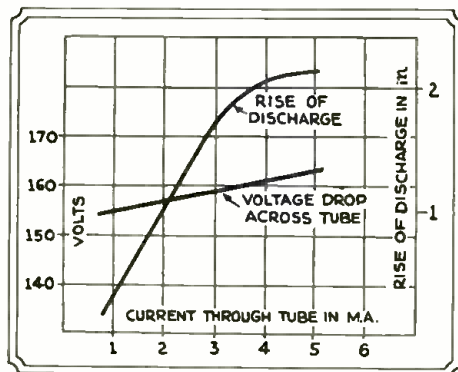

Fig. 1
Electrical characteristics of "Tune-A-Lites."

volume will be reached where the tube will just *begin* to glow. This voltage is called the "ignition" voltage. If the potential across the tube be further increased, the *intensity* of the glow increases, but in this particular tube it is spread out so that the *length* of the glow increases.

This is the important feature of the tube. The chart of Fig. 1 shows how the rise of the glow discharge varies as the current through the tube is increased.

To determine the ignition voltage, and the potential at which the tube will "go out" (called the "extinction" voltage—they are different in the majority of gas tubes) the circuit of Fig. 2 is used. The value of R is increased from zero until the tube *just glows*. The value indicated by V is the ignition voltage. If the resistance R is decreased, from a high value, until the tube *just goes out*, the value of the potential as read by V will be the extinction voltage.

The circuit of Fig. 3 may be used to determine the approximate length of time that these tubes may be used at their rated-maximum current of 8 ma.

A brief review of the theory underlying

the principle of operation of this type of volume indicator will not be amiss.

Automatic Volume Control

These tubes are especially adapted to receivers employing A.V.C., that is, automatic volume control; although they may be used

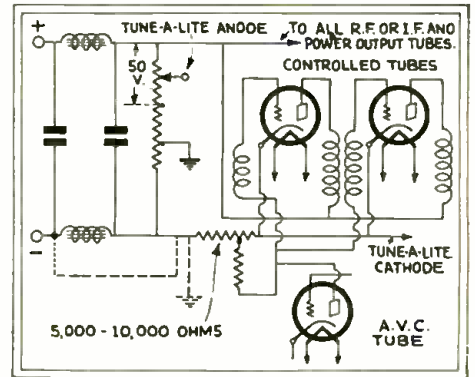

Fig. 8
Connection required for receivers employing a separate A.V.C. tube.

with manually operated V.C. receivers. When a signal is applied to the grid of an amplifier tube, the plate current of course alternately increases and decreases with the signal, the *average* plate current remaining the same. The signal voltage passes to the V.C. tube which, as a consequence of its action, increases the grid bias of the amplifier, thus *lowering the average plate current*. The actual plate voltage therefore rises due to the decreased voltage drop in the plate circuit of the tube. The Tune-A-Lite takes advantage of this situation and uses it for its operating principle.

From the theory of operation outlined above, it is obvious that the tube should be connected between those points in the cir-

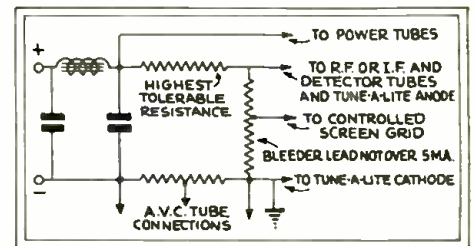

Fig. 6
Connections for receivers using resistance filtering.

cuit, whose voltage will increase and decrease with the signal. Suppose the amplifying tubes that the A.V.C. controls all have their "B+" leads connected together at a common point before entering the power unit, and a high resistance be placed between this common connection and the power unit as shown in Fig. 4. Now if the Tune-A-Lite be connected between the common point and the bleeder resistance in the power unit, it will function for the following reason.

(Continued on page 301)

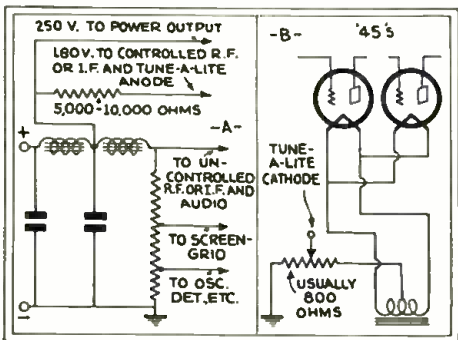

Fig. 7

Using the neon tube to indicate distortion in A.F. amplifiers. At A, the anode connection; at B, the cathode.

INTERESTING RADIO DEVICES

the trade, Service Man, and home-constructor.

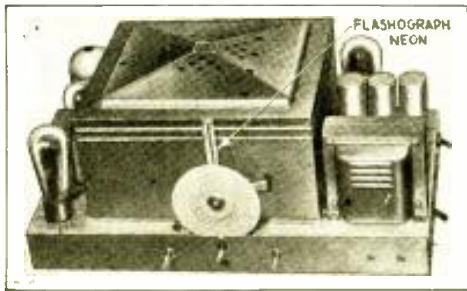

Fig. A

The Fada "Flashograph" models "48" and "49."

THE FADA MODELS "48" AND "49"

WITH the coming of Fall, manufacturers have been advertising their latest contributions to the radio field. The Fada models "48" and "49" are alike electrically; the model "48" is a Lowboy and the "49" a Highboy) recently announced, possess some rather unique features which warrant attention.

The chassis of these receivers, Fig. A, is of the superheterodyne type, employing four type '35 variable-mu tubes in the single R.F., first detector and two intermediate stages; three type '27 tubes for the oscillator, second detector, and first A.F.; two '47 pentodes in push-pull for the final audio stage, and an '80-type rectifier. The use of variable-mu tubes reduces to a considerable extent hum, hiss, cross-talk and other background noises.

To avoid the effect of internal vibrations (microphonics, etc., which sometimes are encountered because of vibrating tuning condenser plates), the entire variable condenser assembly is shock-mounted.

The A.F. component of the output of the second-detector, Fig. 1, is passed on to the first A.F. tube, while the D.C. component is used to change the grid bias on the R.F. and I.P. tubes for automatic control of volume.

Instead of using the conventional tuning meter for visual indication of station resonance, these receivers employ the new neon "Flashograph" which is described in this issue. "Fada" products are manufactured by F. A. D. Andrea, Inc.

SCREEN-GRID AUTOMOTIVE RECEIVER

AN exceptionally sensitive and selective automotive receiver employing standard "A.C."-type tubes is the "Advance" Automotive Radio Set illustrated in Figs. B and C. This chassis has been tested by Radio-Craft Laboratories and merits special attention.

On a cross-country trip of considerable length, this receiver easily met all expectations, bringing in not only the programs of nearby stations, but also those originating at considerable distances. Of considerable interest was the manner in which stations could be heard in so-called "dead spots"; and it was only when passing big power plants or going under large metallic structures (bridges, etc.), that any change in results was noticed. In the former instance a certain amount of static was picked up; and in the latter, the signal volume was temporarily reduced.

Figure C illustrates the convenience of the control-unit placement. A single box comprises the tuning knob, tuning dial, volume-control knob, and a key-lock switch. The control cable from this, leads underneath the instrument-board, as shown in Fig. C; and continues on through to the opposite side of the dash-board, as shown in Fig. B.

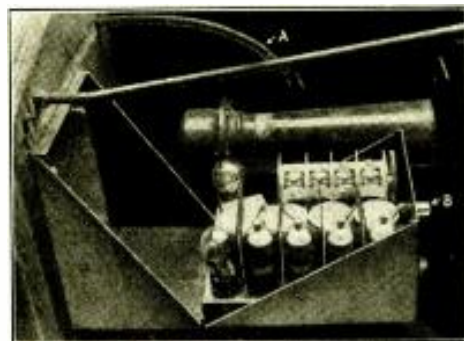

Fig. B

View of the Advance automotive receiver chassis; and tuning cable, A.

The structural conveniences built into this chassis should appeal to every Service Man

installing one of these receivers; and should appeal also to the consumer, who may be called upon from time to time, to replace a tube or two. As shown in Fig. B, the metal cabinet (which acts also as a shield) is divided into two sections; one of which bolts to the dashboard, while the other is hinged, and drops to the position shown, for convenience in installation and service. Thus, the "Advance" set may be serviced in less time than almost any other automotive chassis. The aligning condensers are readily accessible.

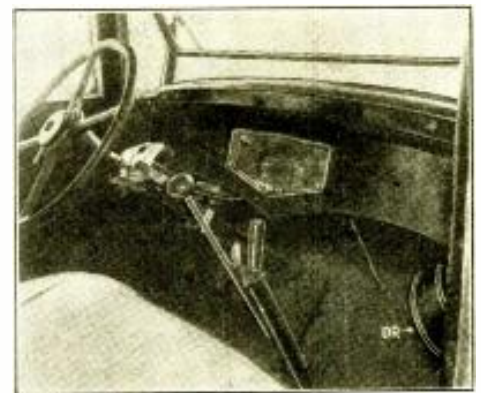

Fig. C

Control unit (on steering post) and dynamic reproducer, DR.

The tuning shaft A must be disengaged from the gear system controlling the tuning condensers, when the cabinet is open; in the closed position, it locks into a receptacle, B.

The "Advance" chassis, which is manufactured by the Advance Radio Co., incorporates cathode- or heater-type tubes, thus eliminating the noise pickup in the tubes preceding the output power tube; four '27's, and a '71A power output tube being used.

A particularly convenient and efficient installation, showing the position of the dynamic reproducer is illustrated in Fig. C. This unit, DR in the figure, is of the "automotive" type, and therefore incorporates design features which overcome the difficulties incident to operating a radio set in a moving car.

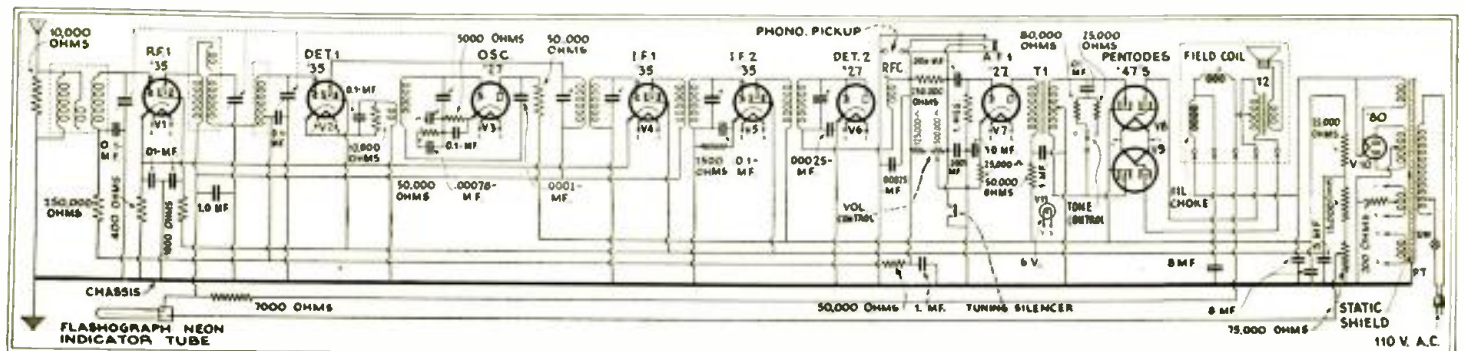

Fig. 1

Diagram of the Fada models "48" and "49" receivers. This chassis is of the superheterodyne type employing a diode detector, a Tune-A-Lite for indicating maximum response; and is equipped with an automatic volume control and push-pull pentodes.

SUPERHETERODYNE-TYPE CONDENSER GANG

A NEW line of gang tuning condensers, the recently announced models "300-A" and "100-A" (the former illustrated in Fig. A), has several features that are worthy of mention.

The entire assembly is completely shielded, and each condenser in turn, is shielded from the one adjacent to it. This unit is particularly adapted to superheterodyne receivers. When the R.F. tuning condensers are connected to a coil of 232.7 microhenries and the oscillator condenser to a coil of 187.7 microhenries, the receiver will tune from 550 to 1500 kc.

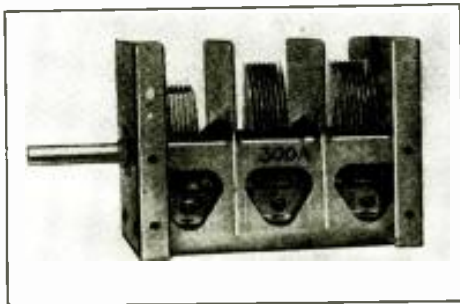

Fig. A

The type "300.1" superheterodyne-type 3-gang condenser.

The most important feature of this "superheterodyne-type" variable condenser gang, which is manufactured by Precise Products Co., Inc., is that it eliminates the "padding" condensers previously required in order to maintain correct ganging over the entire tuning band.

A "DOG" FOR SERVICE WORK

A RECENT development in the field of radio service instruments is the introduction of a "dog" or clamp for the purpose of tightly holding a condenser, dial, or volume control shaft while adjustments are being made on the receiver; this unit is the "shaft catch" illustrated in Fig. 1.

The "shaft catch" is designed to fit all standard radio sets; and may be attached or removed in a moment. A felt pad on one face of a "U"-shaped piece prevents marring the panel.

The "dog" itself is only 3 1/4 ins. long and about 1/2-in. wide, and consequently should find a place in the Service Man's kit.

This tool is distributed by Blanche Radio Man, Inc.

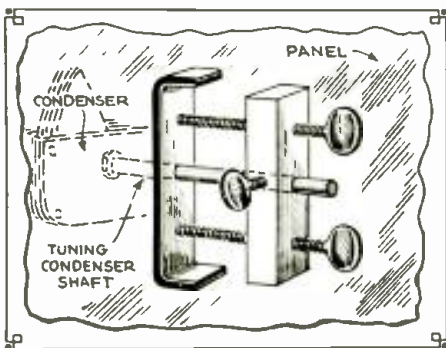

Fig. 1

When the thumb screws are turned, "frozen" shafts are easily removed.

THE NEW PHOTOELECTRIC CELLS

PHOTOELECTRIC CELLS have been used in the past for a variety of purposes, and to further popularize their utility, two new cells have made their appearance on the market. One is a potassium cell shown at left, Fig. B; and the others are of the caesium type.

The potassium type has a sensitivity of 5 microamperes per lumen. It has an anode of nickel ribbon, the bottom of which is

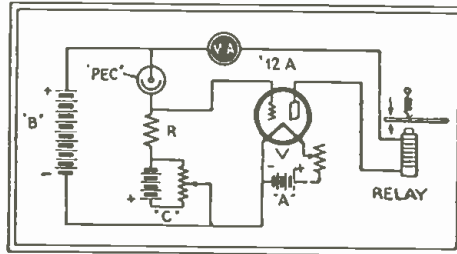

Fig. 2

Diagram of connections for the "PE" cells.

screened to prevent any leakage between the anode and cathode.

The caesium cell has a much higher sensitivity, or 28 microamperes per lumen. The photo-sensitive surface is coated with a very thin layer of caesium—hence the name.

Figure 2 illustrates the manner in which a light-sensitive or photoelectric "PEC" may be connected so as to operate a relay, which in turn may actuate any electrical circuit desired. When a potassium cell is used the value of R should be about 10 megohms,



Fig. B

Left potassium cell. Right, and center caesium cells.

and the "B" approximately 135 volts. If a caesium cell is used then R should be about 2 megohms, and the "B" potential 90 volts.

These cells are manufactured by the Arco Tube Company.

A BATTERY-OPERATED SUPERHETERODYNE

THE new RCA-Victor Model R-43 Radio Receiver illustrated in Fig. C is "self-powered." It is an 8-tube battery-operated superheterodyne receiver employing the Eveready "Airedd" type of "A" battery, and four heavy-duty "B" batteries. There are five type '30 "general purpose" tubes, and three screen-grid '32's in this receiver.

Since the aircells are rated at 600 ampere-hours, and since the current drain of the receiver is only 0.18-amp., it is possible

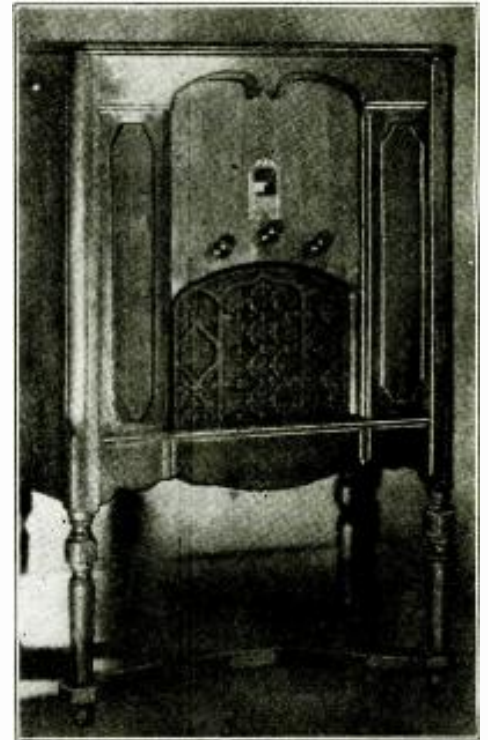

Fig. C

RC-1-Victor Radiola Console R-43.

to obtain 1200 hours of operation.

This chassis brings to those who are located in "D.C." districts, or where there is no power supply at all, the numerous desirable features of its big brother, the "electric" set.

High power output is obtained through the use of two type '30 tubes in push-pull; their output is fed to a magneto-motive (or permanent magnet) type of dynamic reproducer; built into it is a special frequency-compensating circuit.

A PENTODE-TYPE POWER TRANSFORMER

A NEW power supply transformer especially designed to accommodate three to five heater-type tubes, a pentode, and an '80 rectifier, has been offered to manufacturers of "small-space" receivers.

This new unit, illustrated in Fig. D, is built with a single shield for "through chassis" mounting, and is equipped with conveniently located soldering lugs, arranged for an efficient circuit layout.

There are four windings; a primary, a high-voltage (480 volts on either side of the center-tap) secondary, an '80 filament winding, and a heater winding.

Figure 3 is a schematic illustration of the instrument, which is manufactured by the Thordarson Electric Mfg. Co.

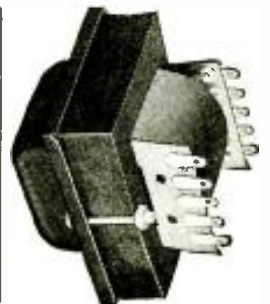
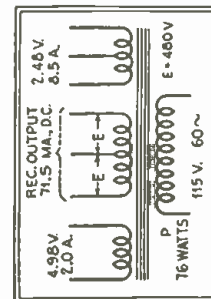

Fig. 3, left. Windings of the "pentode" P.T. Fig. D, right. Photograph of the transformer.

A SIMPLE TEST PROBE

A SIMPLE TEST probe, that may be carried in the vest pocket, and used for a variety of purposes, has been offered to the radio service field. The general construction of the device is illustrated in Fig. E; a small flashlight lamp, housed in a partially concealed socket is the indicator. Some of the purposes for which this probe may be used are: Locating condenser opens or

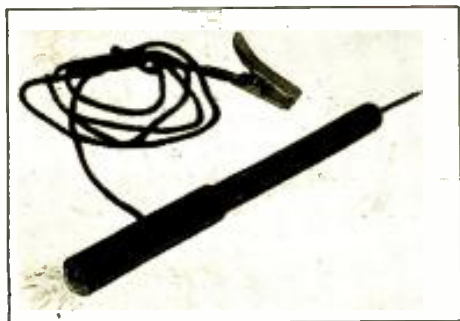

Fig. E

The test probe and battery leads.

shorts, burned-out resistors and wiring, checking the presence of filament or heater voltages, testing the continuity of all low-resistance circuits, checking the correctness of tuning coil polarity, aligning tuning condensers, and for testing high voltage and low current with a neon tube. It is also a very handy trouble lamp.

This simple and convenient device is produced by the Electrical Manufacturing Corp., Boston, Mass.



Fig. F

A new combination volume control and line switch.

A COMBINATION LINE AND VOLUME CONTROL SWITCH

COMBINATION line and volume control switches have been in use for some time, but should be especially adaptable in present day midget, automotive and aeroplane receivers; in fact, in any location where space is at a premium. One of several new combinations recently announced, is indicated in Fig. F.

They are products of the Clarostat Manufacturing Company.

RESISTOR REPLACEMENT GUIDE

AT some time or another, every Service Man has had occasion to replace resistors in a receiver, but was at a loss to know the exact size or type required. While service manuals are the ideal solution to the problem, they are necessarily bulky, with the result that many men do not carry them
(Continued on page 308)

“Haywire Antennas” vs. the Antenaplex System

(Part II)

By E. JAY QUINBY*

THE advantages to be gained by the installation of the “Antenaplex System” of radio reception in a typical apartment house or multi-family dwelling are obvious to those of us who have already been initiated, but for the benefit of those who have not had the experience of struggling along under the handicap of the usual topsy-turvy tangle of antenna wires and crossed-up lead-in lines, the outstanding points are listed herewith:—

1—Elimination of the disorderly and unsightly jungle of wires and their makeshift supports, which clutter up the roof and make for inconvenience and hazard to the persons desiring to use this valuable open-air space for other purposes.

2—Elimination of the unsightly lead-in wires usually run down through court yards and along side of building walls, which present an encumbrance to awnings, flower boxes, and balconies, and which often mar the otherwise pleasant vistas from the windows of the various apartments.

3—Elimination of the noisy and intermittent reception and interference so often caused by various antenna wires and lead-ins swinging together.

4—Elimination of extended interruptions to programs caused by a carelessly erected antenna falling across several others, and creating short circuits and grounds.

5—Elimination of the interaction, caused by re-radiating receivers connected to antenna wires run in close proximity to other antennas.

6—Elimination of the fire hazard caused by improperly installed antennas with unauthorized types of lightning arrestors, or without benefit of any lightning arrestors.

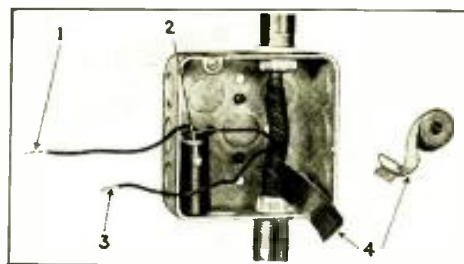

Fig. G

An oversized outlet box is used for the convenience of the installers. The antenna lead is shown at 1, the taplet, 2, ground lead, 3, and rubber tape, 4.

7—Elimination of the broad-tuning effect so often caused by excessively long lead-in wires, which are necessary to reach the roof-top antennas of tall buildings.

8—Elimination of the local interference

* National Sales Engineer, Centralized Radio, R.C.A. Victor Co., Inc.

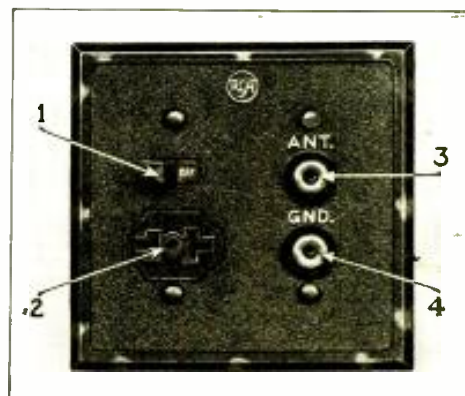

Fig. G

Combination radio outlet, line receptacle and line switch.

so often picked up by long lead-in wires, from such sources as X-ray or violet-ray devices, electric refrigerators, oil burners, elevator motors and controls, signal systems, telephone systems (particularly the dial type) vacuum cleaners, thermostat regulators (in electric irons, heating pads, light flashers, etc.), flashing electric signs, neon lights, and a host of others too numerous to mention.

9—Elimination of the wear and tear on the premises, caused by the continual construction and reconstruction work on antennas, as old tenants leave and new tenants arrive—and as permanent tenants change their ideas on the subject of antenna construction.

10—Elimination of the handicap endured by tenants on the lower floors, who never get as good results as those situated closer to the roof—and the antenna.

These are some of the reasons why the Antenaplex system adds to the comfort and enjoyment of the dweller in a multi-family house.

The process of installing the system in new construction work and in existing structures is very simple. First, we will describe the procedure in a new construction job, beginning with the original layout work, or “survey.”

Survey and Layout

If the building construction has advanced sufficiently far, it is advisable to make an actual test at the top of the structure to determine the best location for, and direction in which to run the antenna, employing a portable battery type receiver for this purpose. If, however, the building is still “on paper,” it will be necessary, of course, to defer this operation until a later time. The “antensifier,” Fig. A, or group of “antensifiers,” as the case may be, should be located in a pent house, as near as possible to the proposed antenna lead-in.

(Continued on page 302)

REMOTE CONTROL of Public Address Sound Amplifiers

(PART IV)

Continuing the discussion of high-power amplifier systems as engineered for the best operation in large institutions.

By ELI M. LURIE, B.E.E.

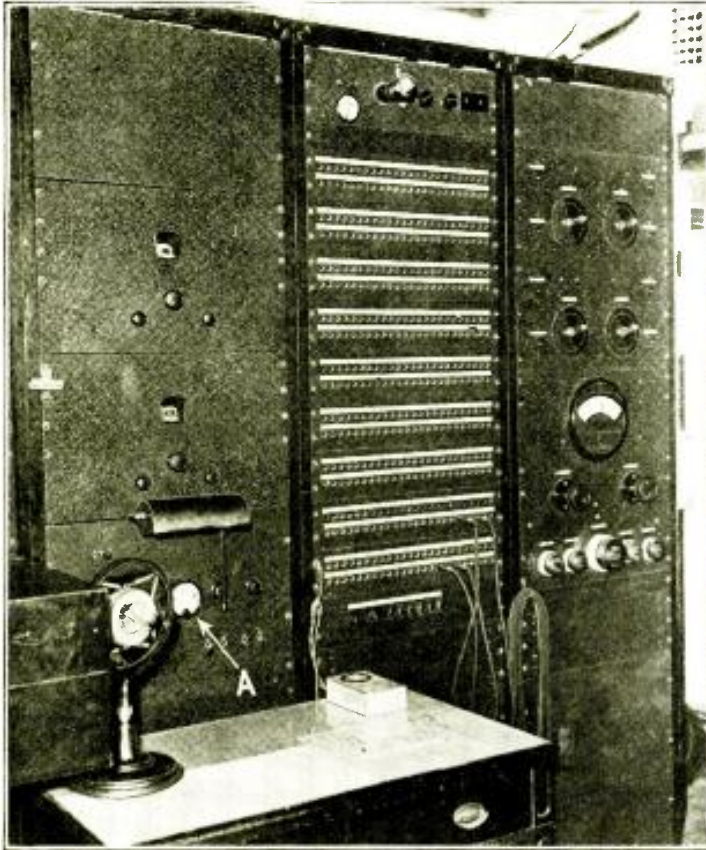

Fig. C

A photograph of the control panel of the Hotel New Yorker, showing the distribution jacks; and, A, volume-level indicator.

IN this article, the fourth in a series (the third article describing this installation, and entitled, "Remote Control of Radio Reception," appeared in the August, 1931 issue.—*Tech. Ed.*), we continue with a description of the remote controlled Public Address System in the Hotel New Yorker.

One of the notable features is the method of remotely connecting the speakers. On the remote control box are six buttons. Five of these buttons are arranged to operate speaker relays, which place various speakers into operation by connecting the voice coils to the line. The sixth, or the button labeled "Reset," when pushed, disconnects all the voice coils from the line. Thus it is possible to go into any of the public rooms, plug the remote control box into an outlet, tune in a broadcast station and then by merely pushing the speaker buttons, transfer the signal to any or all of the other public rooms.

The schematic circuit of the relays (Note 1) used for this purpose is shown in simplified form in Fig. 1 and a photograph is shown in Fig. A. The wires A, B, C, D, E and "Reset" go directly to the remote control box outlets. When the remote control box is placed into operation, these wires are connected to the buttons on the box. As a button is pressed, the relay corresponding to that button operates and pulls down an iron lever or relay arm which throws the voice coil of that speaker into the output circuit of the P. A. The lever arm continues to remain in this position until the use of the speaker is no longer desired. When the "reset" button is pushed, all the speakers are simultaneously discon-

nected from the output circuit of the system.

In addition to the five remotely controlled dynamic speakers there are portable speaker outlets placed throughout the building. Therefore, any number of speakers may be connected, but only the five main speakers are operated remotely. A "Lectern" or speech re-enforcement speaker is also used. This speaker consists of a "cluster," or group, of three dynamic speaker units operating together, and is used almost entirely for speech re-enforcement in the center of the Grand Ball Room.

Phasing of Reproducers

The dynamic speakers used in the New Yorker have an impedance of 15 ohms. The fields each require 110 volts at .75-ampere; this is supplied by the D.C. lighting system of the hotel. Each speaker or group of speakers has an impedance-matching transformer mounted directly at the speaker. It matches the impedance of the speaker to the transmission line, which has an impedance of 500 ohms.

A very important test that must be made when a group of speakers are operated together is that of correctly "phasing" them. To be correctly phased, the voice coils of all the speakers must "push and pull" together. If a speaker unit is "out of phase," then its voice coil will be "drawn in," while the voice coils of the other speakers are "pushing out." Under such conditions the sound emitted by the "out-of-phase" speaker will actually represent the back wave of the ordinary dynamic speaker operating with a baffle board. If the baffle board of a dynamic speaker is removed, then the low notes immediately disappear. This phenomenon is due to the back wave, generated by

the back of the cone, meeting and neutralizing the front wave from the front of the cone.

To phase the speakers it is only necessary to apply the field voltage to the speakers, and then connect a dry cell to the voice coils and notice the direction of motion of each coil when the dry cell voltage is applied. The polarity of the dry cell should be the same on all voice coils. By touching the cone on each speaker its direction can readily be determined. When the phasing is correct, all of the voice coils should push out, and draw in, together. Reversing the connections of any individual voice coil will change its direction of motion. By using this method it is a simple matter to phase any number of speakers that are operating together.

In the New Yorker, only direct current is available. The Radio Division of the hotel therefore utilizes several motor-generator

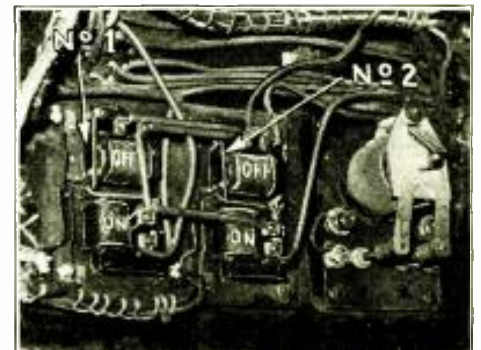

Fig. A

Speaker off-on relays Nos. 1 and 2; and, extreme right, channel A.C. input relay.

sets in order to obtain alternating current. In Fig. 2 is shown the relay system for starting the public address system. As mentioned previously, the entire P. A. System is remotely controlled and, therefore, when placing the system in operation it is imperative that starting devices be used in order to eliminate any possibility of the apparatus being overloaded.

On opening the remote control box, a button inside it is released, which automatically closes the circuit through relay No. 1, (Note 2) Fig. 2, and starts up a 2 horsepower motor. At the same instant, the dynamic speaker field voltage is applied to all speaker fields by the closing of relay No. 2, and the A.C. generator field voltage is applied by relay No. 3. The motor, therefore, begins to turn over. The automatic starter regulates the armature current and gradually brings up the motor speed. As it increases, the A.C. generator also increases its speed and begins to produce voltage. As soon as the generator voltage is high enough, the A.C. relays (Note 2) 4, 5 and 6 operate, throwing the public address system across the generator line. The generator, therefore, does not start up under load conditions.

Time Delay Relays

The plate voltage on the power tubes is not applied until the time delay relays, a photograph of which is shown in Fig. B, and a diagram in Fig. 3, operating in the plate circuit, have allowed the filaments to heat up, and then, after a period of about a minute, these relays close and the entire public address system is in operation.

The relay is actually a thermostatic relay (Note 2) operating in conjunction with a second, or main relay. On starting, the thermostatic relay is connected directly across the A.C. line. The thermostat heats up and the unit expands until it closes the gap at point X. As soon as this connection is closed, the line voltage is connected directly to the main relay coil. The coil magnetizes the upper lever arm and pulls it down closing the line circuit to the plate transformer. The instant the main relay coil pulls the upper lever arm down, the thermostatic relay is disconnected from the circuit and the main relay coil continues to obtain voltage from the line. However, when the system is shut down, the generator stops and the main relay coil then releases the

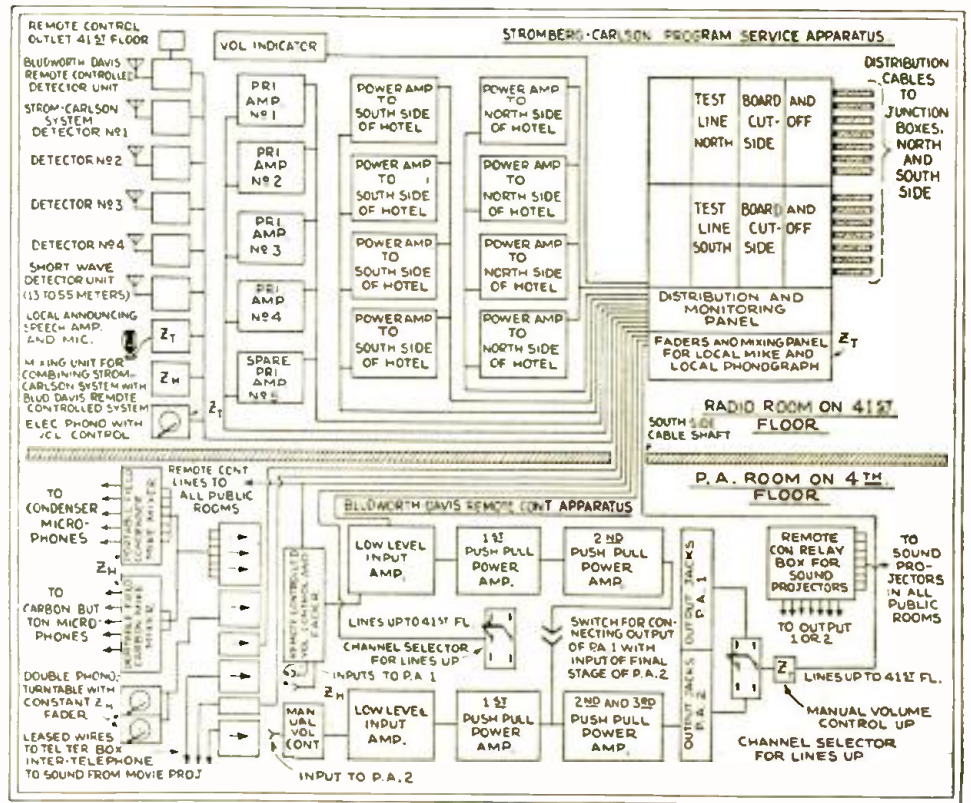

Fig. 5

A block diagram of the entire installation of the Hotel New Yorker. Note the use of the volume indicator for the guidance of the control operator in the Radio Room.

ever arm and the spring pulls the lever arm back, connecting the thermostatic relay

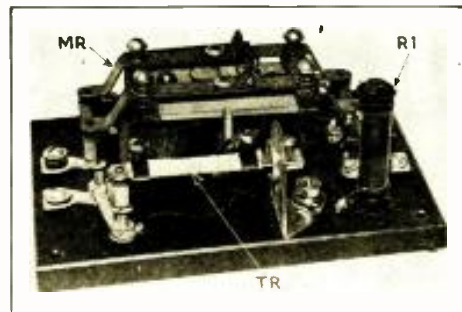

Fig. B

The plate-voltage thermostatic relay.

once again across the line, ready for service when operation is once more desired. Many people have asked why the loud-

speakers in the guest rooms were not of the concealed, flushed wall type. The answer is very simple. The use of enclosed wall speakers presented several difficulties that possibly could be eliminated if the installation were anywhere except in a hotel. Most people that stay at a hotel expect to be able to sleep at any time that they are so inclined. Naturally, therefore, the first asset of any good hostelry is not to have disturbing elements which will tend to antagonize a guest. If an enclosed speaker is set into a wall, the air column in that wall will be set into vibration when the speaker is in operation, resulting in vibration of adjacent walls; thus the people in all the surrounding rooms will be disturbed by the sound.

If, on the other hand, the loudspeaker be mounted externally, as in the New Yorker, then the wall in the room itself will be the only vibrating factor. Now, if the walls are made of sturdy material, and the speaker is mounted on rubber lugs so that the vibrations of the cone are not transmitted to any great extent to the wall itself, then there is little possibility of exciting the inner air chamber. If the chamber is excited, the vibrations will not come from the speaker, but from the entire room itself, which in most cases is not enough to cause serious disturbance in adjoining rooms.

Measurements made by both Stromberg-Carlson Company and the Radio Division of the New Yorker indicate that the correct level is approximately 10 decibels.

Decibels

The question of "decibels" or "DB" is one which has caused considerable confusion. Most technical writers refer to this measurement as a "ratio between certain powers," but fail to give to the layman workable

(Continued on page 304)

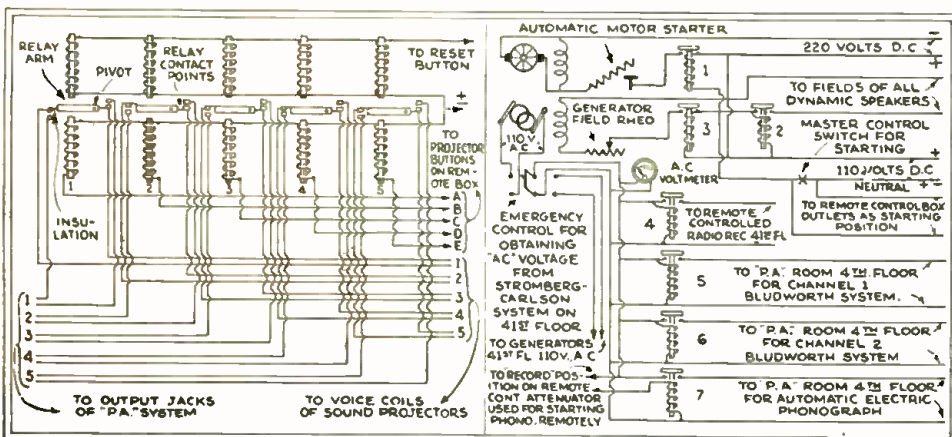

Fig. 1

Left. The relay system for remote control of speaker operation. When the "reset" button is pressed all speakers are disconnected. Right. Relay system for control of motors and transformers.

Fig. 2

Magic in

PART

Much material has been presented in past procedures in adapting meters to the requirements of a series, Mr. Clifford E. Denton, (who is on meters), discusses the factors which

By CLIFFORD



A modern Vacuum Tube Voltmeter (front view).

IN the last few years the use of electric meters for quick and accurate testing of radio and sound equipment has increased by leaps and bounds.

Looking at commercial meters today, we can hardly visualize the path of heartbreaking development that has extended through hundreds of years; groping for the fundamental principles, wading through false beliefs and hypotheses, all of which finally led to the development of the first measuring instrument—the “galvanometer.”

Magnetic and static electricity was known as early as 600 B.C., but even then, and until 1600 A.D., no one realized the distinction between the two.

Later, a relation between electricity and magnetism was established, and from Ampere’s idea of a simple needle suspended above a wire carrying current, came the findings of Pouillet, in 1837, where the degree of deflection of the needle from its original position indicated the intensity of the current flowing in the circuit.

It was realized early in the development of the art that a system of convenient standards would be necessary. Consequently, a system of practical units was

adopted, which were derived from the C.G.S. (centimeter, grams, second) System.

This system of units led to the development of various complicated but interesting devices for the accurate determination of electrical values. (A detailed discussion of this system and its uses will be found in S. Gernsback’s “Radio Encyclopedia,” Second Edition.—Tech. Ed.)

“Absolute” Measurements

The first method was shown by Faraday. He placed a pair of clean copper plates in a solution of sulphate of copper (blue vitriol) and passed an electric current through the solution. The current dissolved some of the copper from one of the plates and deposited an equal weight of copper on the other plate. Faraday showed that there is an exact relation between the strength of the current and the amount of metal removed or deposited.

Lord Rayleigh employed silver plates and a solution of silver nitrate. He found that there is deposited in one second, .001118 gram of silver, or 4.025 grams per hour. The amount of current causing this deposit is called an “Ampere.” One ampere will deposit 1.177 grams of copper per hour.

The “International Standard Ampere” is

now legally defined by International agreement in terms of the amount of silver deposited by it, as stated above. Figure 1A is a rough outline of how the measurements were made.

In 1898, Professors Ayrton and V. Jones designed a device called an “ampere balance.” This instrument is illustrated in

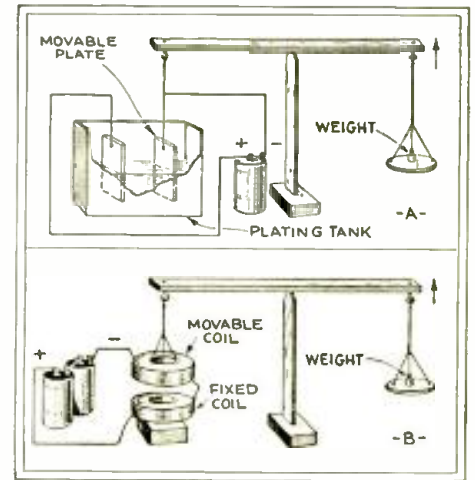

Fig. 1

At A is illustrated the electro-deposition method of measuring current; at B, dynamic method.

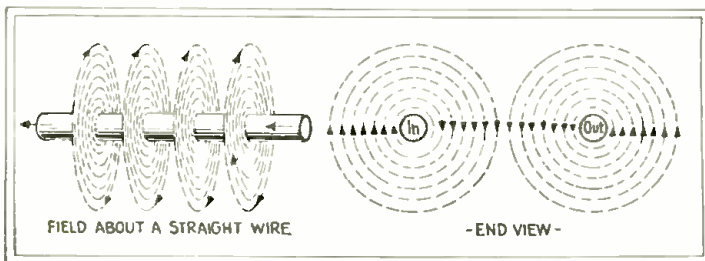
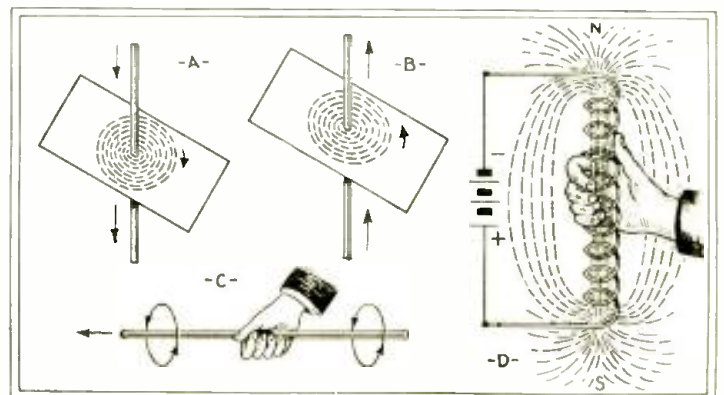

Fig. 4, above

The magnetic lines of force at right angles to the direction of flow of current in a wire.

Fig. 5, right

Specimens, A and B, of the magnetic field around a wire. Use of the “rule o’ thumb” is indicated: at C, for a wire; and D, for a coil.



Meters

I

issues of RADIO-CRAFT, describing the various
ments of radio service work. In this article, the
well-known as a radio writer, and who lectures
enter into the design and use of meters.

E. DENTON

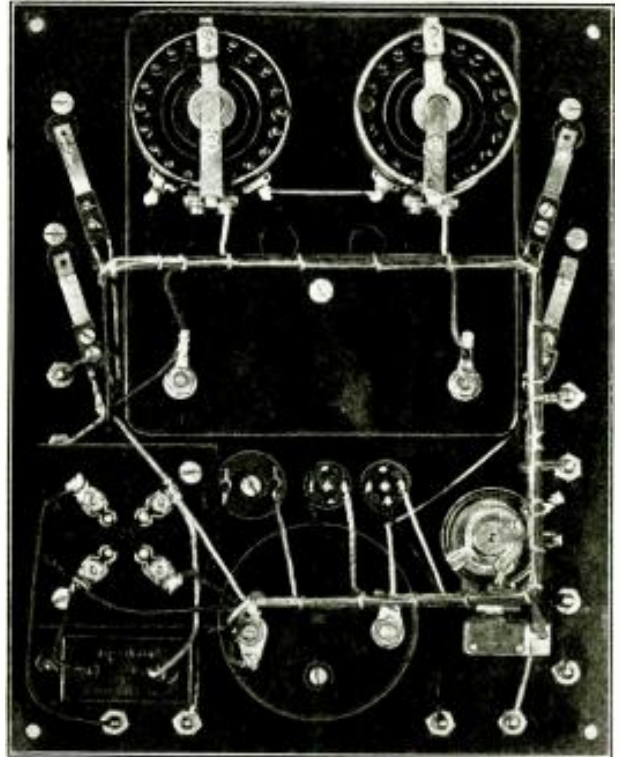

A modern Vacuum Tube Voltmeter, rear view.

Figure 1B, and consisted of a very delicately
balanced pair of scales, on one scale of

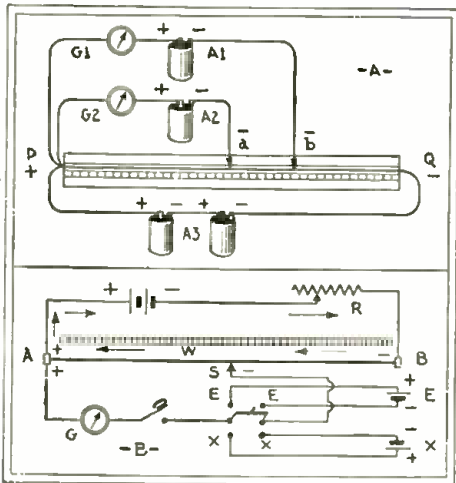

Fig. 2

At A, above, the Poggendorff "potentiometer,"
and B, a commercial adaptation.

which were placed weights of known value,
and from the other was suspended a large
movable coil. The latter then was placed
above a fixed coil rigidly mounted on a base.

The scale was adjusted to balance by
adding weights to counteract the weight of
the suspended coil. Upon passing current
through the coils, the moving coil was pulled
down by the magnetic lines of force. The
additional weights necessary to bring the
scale back to balance gave an accurate
indication of the weight or force of the elec-
tric current. Thus it was determined that
the addition of every "gram of weight"
represented 980 "dynes of force."

The difficulty of applying this system was
the spur which caused Professor Fleming to
devise, in 1883, a much easier scheme for
measuring voltages or currents. He made
use of a then-existing instrument called a
"potentiometer," Fig. 2, devised by Poggen-
dorff in 1841, and modified by Fleming.

If a resistance "slide-wire" P-Q is
stretched over a scale, and a steady (bat-
tery) current is passed through it, a drop

in voltage across this wire will result.

Connected to the positive end of this wire
are two other wires 1 and 2, with sliding
contacts on the free ends, and in series
with these wires are placed two galvanom-
eters G. It will be seen that current flowing
through P-Q will be partially deviated
through wires 1 and 2 and the galvanom-
eters connected in series.

In the circuit of wires 1 and 2 are in-
serted two different sources of electricity,
A1, A2, so placed that their E.M.F.'s.
(electro-motive-forces) or "voltages" (the
term honors *Alessandro Volta*, an Italian
physicist) tend to oppose the voltage drop
produced in the wire P-Q by the current
source A3. If the sliding contacts be moved
until the voltage drop from the sliders to
the negative end of the main wire P-Q just
balances the E.M.F. of the inserted cells,
A1, A2, the galvanometer will indicate zero.
That is, the E.M.F. in each circuit being

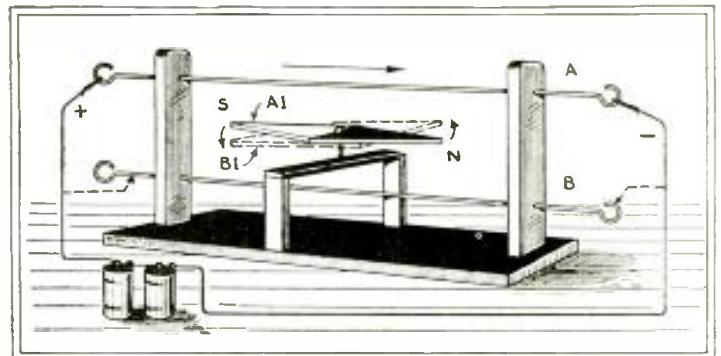
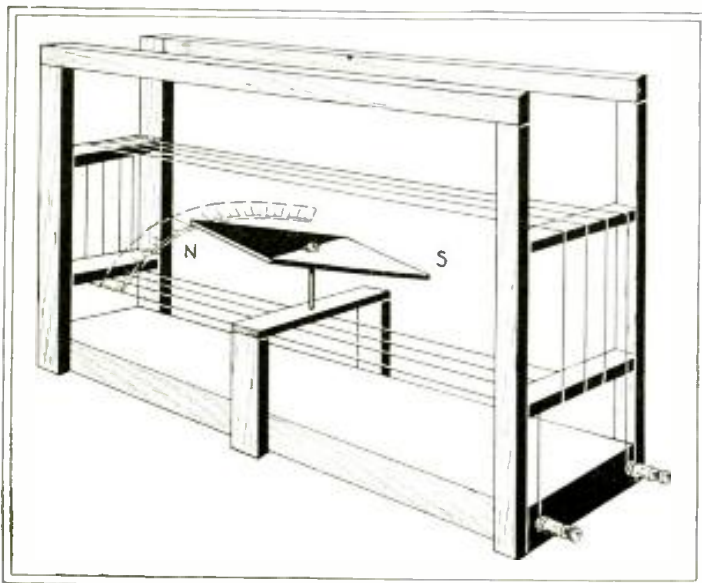

Fig. 3, above, Oersted's
deflection demonstrator;
Fig. 3, left, Schieffelin's
"multiplier."

opposite in polarity and equal in strength,
no current can flow through the galvanom-
eter. The E.M.F. of the two cells is then
proportional to the E.M.F. drop across P-a
or P-b (depending upon which meter is be-
ing read). The slide-wire may be calibrated
by the substitution of known values of
E.M.F.

The simple slide-wire type of potentiometer thus proves useful for comparing "voltages," and is commercially available today; being rated as of low-potential or high-potential type, depending on the resistance of the slide-wire. See Fig. 2. (See also, "A Home-made Slide-wire Bridge" in the Feb., 1931 issue.—*Tech. Ed.*)

The principle of operation of the commercial slide-wire potentiometer is the same

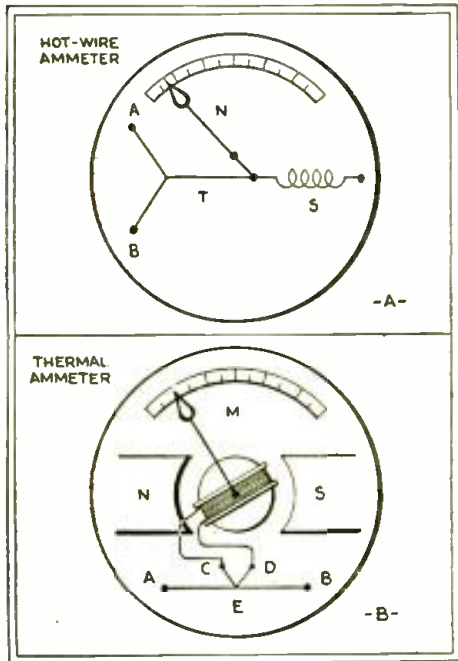

Fig. 7

"A.C." meters. At A, "hot-wire" type, and; B, a "thermocouple" instrument.

as above described, and the scale is calibrated in the proportion of the total resistance of the wire, or in volts. In Fig. 2B the standard voltage is shown at E, and the voltage to be measured at X.

First Principles

The fact that a current from a battery when passed along a length of wire would create a "magnetic field," was first noticed by H. C. Oersted, of Copenhagen, in 1820. He found that a suspended magnetic compass needle always set itself when near a current-carrying wire, so as to lie at right

angles to the length of the wire; and the north-seeking pole of the needle deviated to one side when the wire was above the needle; and to the opposite side when the wire was laid below the needle, Fig. 3. He correctly concluded that this was due to the current creating a magnetic field of force around the wire, the direction of these lines of force being in circles, which lie in planes perpendicular to the direction of the wire, as shown in Fig. 4.

There is a definite relation between the direction of current flow and the direction taken by these lines of force, as shown in A and B, Fig. 5, a fact which enables us definitely to determine the polarity of any "electromagnet."

Rule O' Thumb

A useful reference is called the "rule of the thumb," C, Fig. 5. Simply grasp the wire in the right hand with the thumb extended along the wire in the direction of the current flow, "+" to "-". The curved finger tips will then indicate the direction of the magnetic field.

In the instance of a coil, grasp the solenoid with the right hand so that the fingers point along the wires in the direction of the current flow. The thumb then points to the north pole—that is, the thumb points in the direction of the magnetic flux passing inside the coil, D, Fig. 5.

A man named Schweigger, about 1821, modified Oersted's original idea, and wound many turns of silk-covered copper wire over and under a pivoted magnetic compass needle, in the manner illustrated in Fig. 6. This was called a "multiplier" because it

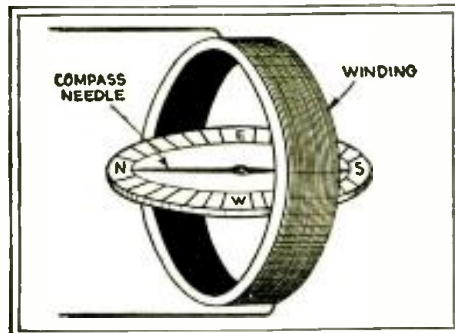

Fig. 8

The "tangent galvanometer."

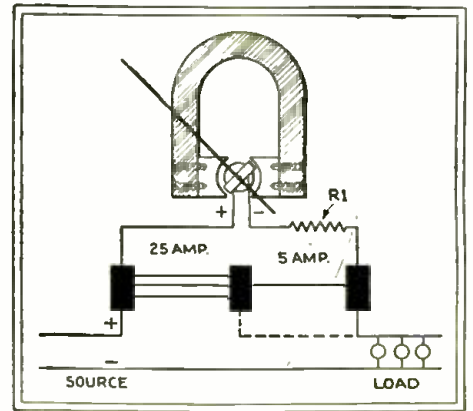

Fig. 9

Schematic circuit of the meter illustrated in Fig. 8. Resistor R1 compensates coil constants. Increased the effect of the current on the needle. This apparatus was the first "galvanometer" ("galvano-", after Luigi Galvani, an Italian physicist).

Since the invention of the galvanometer, measuring instruments have been developed for measuring electricity in all its ramifications.

There are meters for measuring the quantity of electricity flowing in D.C. and A.C. circuits; for measuring the force at which the electricity circulates through the circuit; and for measuring the power developed by the combination of this quantity and force.

Galvanometers sometimes were called "rheometers," from the Greek *rheo*, meaning "to flow," and *metron*, meaning "measure." The "rheostat" (-stat, Greek *stator*, "standing") is the only survival of this terminology; meaning a resistance which can be varied to regulate the flow of current.

Meters may be classified into two major types: (A) Those operating on magnetic principles, and; (B), Those known as "hot wire" instruments which operate by virtue of the expansion of a resistance wire which

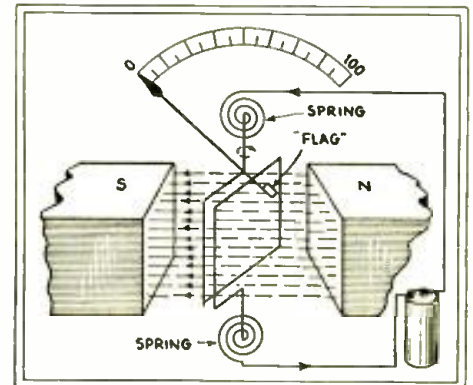

Fig. 10

The D'Arsonval principle of operation.

heated by an electric current. Figure 7B, shows a modification of the magnetic principle where an alternating current heats two dissimilar metals; C and D make contact with the hot wire A-B. The heat produced at the junction or "thermo-couple," E, generates a voltage which is carried to the D.C. meter, M, which indicates in proportion to the amount of current flowing in its circuit. (The theory for this odd effect is still in doubt.) These methods are used to measure "high frequency" currents.

The hot wire ammeter depends for its action upon the expansion of a metal wire (Continued on page 306)

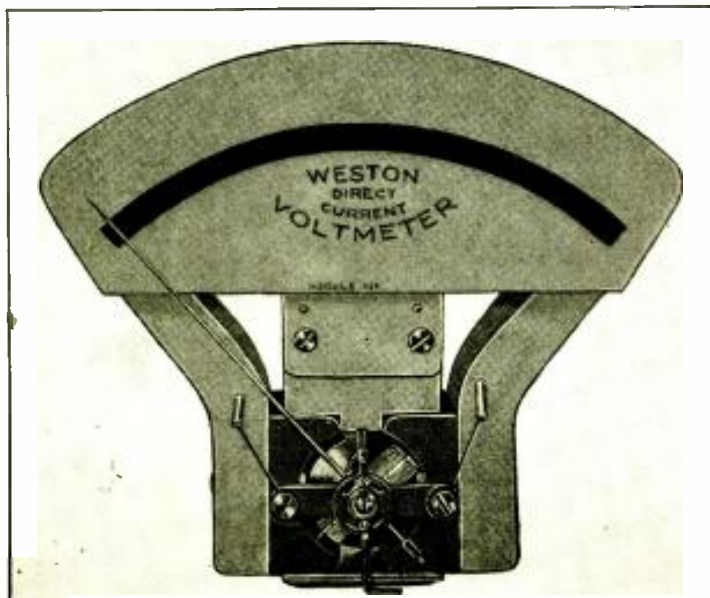

Fig. A

A commercial meter of the "D'Arsonval type. The moving coil turns between the tips of an inverted "U" permanent magnet. Its connections and polarity are shown in Fig. 9. Actually, the direction of current flow is a matter of definition; although it is generally assumed that current enters a meter at the terminal marked "positive," and leaves at the "negative."

The Service Man's Forum

Where His Findings May Benefit Other Radio Technicians

RECEPTION UP NORTH

Editor, RADIO-CRAFT:

I received the issues and wish to thank you for the prompt mailing; they happen to contain exactly the points in circuits and experiments that have been missing links in my study of the best R. C. A. models.

I am not a professional, but only making gifts to people in remote districts of Canada, after I have exhausted all information possible in order to keep them advised on how to operate successfully the Radiola "28" and "VIII," especially.

They report Cuba and Mexico, as well as coast to coast in the United States; except for the northeastern United States and eastern Canada, which still remains a "dead spot," even for research engineers. The point is on the west coast of Hudson Bay, 500 miles from any radio station. With RADIO-CRAFT's advice, wonderful success has been enjoyed.

VIRGINIA B. WALLS,
12 East Division St., Chicago.

RECTIFIER REPAIRS

Editor, RADIO-CRAFT:

Recently it was necessary to service an old Hammarlund-Roberts set, which was equipped with a Philco "B" power unit; the "Philcotron" jars were in bad shape, and no replacements were available in the vicinity. Nevertheless, the set must be in order that evening, since some relative of the owner was making her debut at a broadcast studio. Well, Service is our motto!

Prying off the tops of the four jars, I pulled out their elements and, with a back saw, cut through the insulation of each aluminum (cathode) rod, half an inch from the bottom, as illustrated at A in Fig. 1.

I had in my kit some 3/4 aluminum rod, from which I cut four pieces, each 3/4-inch long; I drilled a hole half an inch deep to fit the exposed core, threaded for 6/32

aluminum screw at the tap on the side; then slipped the extension on the end of the aluminum core and tightened the screw. The joint between the insulation and the aluminum end insulation was covered with three applications of tire cement, to prevent corrosion at this point. Then I got a pint of distilled water and a small box of borax, and made a saturated solution. After that had settled and cleared, the jars were cleaned and filled to the lower line; and ten cents' worth of castor oil was added to prevent evaporation. The tops of the jars are fastened with No. 14 wire around the groove, twisted tight.

If the Service Man runs across one of these power units and is forty-five minutes from Cortlandt Street ("Radio Row," in New York City) he can save three or four dollars and give real service, or build a power unit with these junk parts.

S. M. SMITH,

15 Franklin Place,
Woodmere, L. I., New York.

(Nothing seems quite so aggravating to readers outside the metropolis as the casual air with which a city Craftsman writes: "I picked up this part for 38 cents on Cortlandt Street," when explaining how a set was built around it. But there ought to be a few compensations for anyone who has to take a 45-minute ride in the New York subway.—Editor.)

CONVERTING A STORAGE BATTERY

Editor, RADIO-CRAFT:

I have been a subscriber since the first publication of RADIO-CRAFT, and I am pleased to say that I am quite sure no other publication can equal it for information and the kind of material it contains for the Service Man and for those who delight in experimenting and rolling their own.

I cannot help thinking that many of the old-timers have fallen by the wayside and

no longer build their own as they used to do. I think the reason is that they have been stung so many times by trying the wonderful circuits and constructional ar-

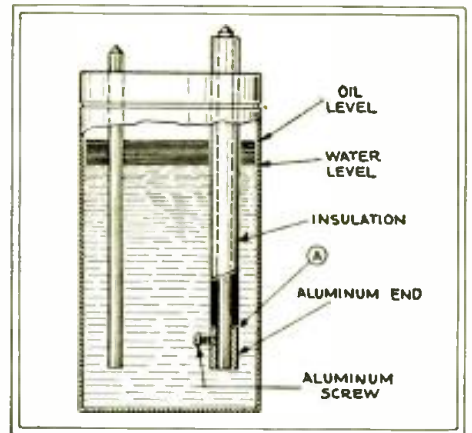

Fig. 1
Rejuvenating a Philco "B" power unit. Part of the aluminum cathode of this "B" jar is replaced.

ties which are published in certain magazines—not RADIO-CRAFT—just for the purpose of filling up their pages. I cannot help feeling that such articles must do a magazine considerable harm; whereas a real good constructional one will increase the circulation to a great extent, and help to build up the interest which should not be allowed to drop.

I have been in the servicing business for the past eight years; but find the same slack in the summer time; so I fill in on construction. By the way, I do not know how I would get along without the RADIO SERVICE MANUAL and its SUPPLEMENTS.

I hope to see in the near future an article dealing with the construction of a real superhet, with the new 30 D.C. tubes.
(Continued on page 308)

Hutchinson Radio Laboratory
17 North Walnut, Hutchinson, Kansas
Call 5070

If there is something wrong with your radio, please let us know. We specialize in the repair of all makes. No job is too small or too big for us.

Burgess and Eveready A-B-C Batteries

Cunningham Tubes
Eveready Tubes National Tubes
R. C. A. Tubes Red Seal Tubes
Majestic Tubes Arcatron Tubes

Our work must be satisfactory with you or no charge will be made. All work guaranteed one year.
No Charge for Mileage Up to 10 Miles—10 Cents Per Mile Thereafter.

Believe It Or Not
We Never Fail
To Fix It

Hutchinson Radio Laboratory
17 North Walnut, Hutchinson, Kansas
PHONE 5070

Complete Laboratory Equipment. Parts of all kinds for all makes of Radios

We carry short wave and amateur Transmitting Supplies

Call 6070 for Western Union Time

This is a most accurate check on your Radio an Its Tubes

Your Radio should be checked every 90 days
We will do it Free of Charge
PHONE 5070

1 2 3 4 5 6 7 8 9 10 11 12 13 14 15

Burnt Out	
Weak	
Good	
Dead	
Weak	
Good	
Perfect	
New	

HUTCHINSON RADIO LABORATORY
17 N. Walnut - Hutchinson, Kan. - Phone 5070
Our Tubes are Guaranteed 90 days against burn out or money refunded

Test
Our Tubes are Guaranteed Six Months against Defective Characteristics or replacements made.

Hutchinson Radio Laboratory
17 No. Walnut Hutchinson, Kan.
PHONE 5070

Your Radio is like your Automobile in one respect. Supposing a sparkplug in your car should miss you would have it changed or fixed because if you did not, it would only ruin your other sparkplugs and possibly your car as well, your Radio and tubes act on the same principle. Have them checked at least every 90 days. Replace good tubes for bad tubes to prolong the life of your Radio.

A good example of a snappy folder. Four pages, 3 1/2 x 5 1/2 ins.; inexpensive plus stock. Left, the front and back, at the right, the

inside pages. Similar advertising should prove a boon to other service organizations.

Favorite Testing

Described In Detail By

Laboratorians, Service Men, technicians in all branches of radio, each have their "pet" improved performance. This month we describe how to "multi-range" an A.C.-type meter; and a very complete service bench.

A 1000-OHMS-PER-VOLT MULTI-RANGE A.C. VOLTMETER

By R. D. Leonard, Design Engineer*

ONE of the important problems in the communication and radio field is the measurement of small A.C. voltages from low power sources at commercial and audio frequencies. The new *rectifier type* A.C. 0-1 milliammeters, such as the Weston Model 301, or the General Electric Type DO 14X, are ideally adapted for this purpose.

It is now possible to construct a multi-range, high-resistance A.C. voltmeter that will provide accurate A.C. measurements.

The circuit diagram, Fig. 1, shows the most convenient method of connecting suitable wire-wound resistors to provide a 0-10-50-100-250-500-1000 volt multi-range A.C. voltmeter. It is extremely important that these specified resistors be used, in order to obtain an accuracy within the limits required for radio servicing.

The correct value of the resistors to be employed may be determined by the use of Ohm's Law.

$$R \text{ (ohms) equals } \frac{E \text{ (volts)}}{I \text{ (amperes)}}$$

In this simple formula, I equals amperes necessary to obtain full scale deflection of the meter, and (in this case) E equals the full scale reading, 0-10 volts.

For example: Using a 0-1. scale milliammeter, that you desire to use as a voltmeter which will have a full scale reading of 10 volts A.C.

$$R \text{ equals } \frac{10 \text{ volts}}{.001 \text{ ampere}} \text{ equals } 10,000 \text{ ohms.}$$

* Shallerross Mfg. Company.

In the case of the 0-1. D.C. milliammeter, 10,000 ohms would be used for the 10 volts step, but in the case of the *rectifier type* 0-1. A.C. milliammeter (the rectifier unit of which has an internal resistance of approximately 1,000 ohms) the proper resistance is only 9,000 ohms.

For small scale readings above 10 volts it is not necessary to make allowances for the 1,000 ohm internal resistance of this meter caused by the rectifier. However, if a value lower than 10 volts is to be read, very careful consideration must be given to the actual internal resistance of this instrument, otherwise, an appreciable error might creep in. Usually, 10 volts is low enough for most A.C. measurements.

MUTUAL CONDUCTANCE METER

By C. H. W. Nason

A TUBE may appear perfectly good as far as the normal conditions of test are concerned and yet fail to come up to the standard of its type. The three factors which really determine the effectiveness of a tube as an amplifier are: the amplification factor (μ); the plate impedance (R_p); and the mutual conductance (G_m). The first two factors are difficult of measurement with ordinary equipment; then, too, either alone fails to give a factor of merit which indicates the desirability of the tube under test as compared with others of its type. The conventional method of measuring the mutual conductance (by checking the change in plate current attending a given change in grid voltage) is clumsy and inaccurate; and it is not a definite indication of the tube under operating conditions.

Not long ago the writer was gainfully employed at a particular labor which demanded the use of tubes of known characteristics. Not only were the operating voltages of each tube checked by means of an analyzer as a matter of daily routine; but each week every tube was carefully checked on a General Radio mutual-conductance direct-reading meter.

After several weeks of regularly trotting my tubes to the whereabouts of a meter, I decided to make the proverbial mountain come to Mahomet.

For various reasons, a simplified meter

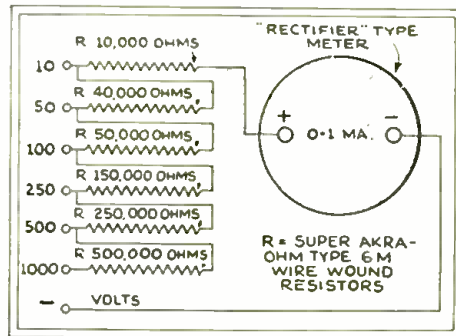

Fig. 1

A "series"-type connection of multipliers.

of the type shown in Fig. 2 cannot be used for extremely accurate tests. The errors present are, however, the same for each type of tube to be tested and, in consequence, they have little or no effect upon the comparative test desired.

As will be seen from the diagram (Fig. 2 at A), the filament supply has two positive leads for use with tubes of low or high current; the low-current rheostat is a 50-ohm unit, for use with tubes having a current rating of up to 0.5-ampere; and the other rheostat, for use with tubes drawing up to 1.75 amperes, has a resistance of 4.5 ohms. A changeover switch, required where the meter is employed with screen-grid tubes, is shown schematically in the sketch.

It should be remembered that the mutual conductance reading indicates, not *what* is wrong with a tube, but the fact that *something* is wrong; whether it be gas, incorrect spacing of elements, low emission or "what have you." Except to admit that a simple bridge structure is the theoretical basis of operation of the device, no discussion of the "why" of its operation seems in order.

The mutual conductance of the tube un-

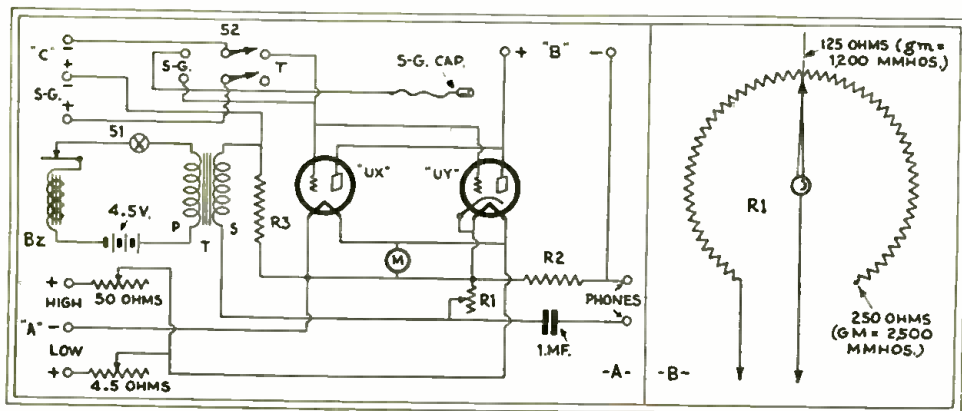

Fig. 2

(A) A "null" method of measuring "Gm." (B) Resistor R1 is adjusted for minimum response.

Equipment

Radio Servicemen

circuit or parts arrangement resulting in meter; a direct-reading tube conductance-Let us hear about yours.

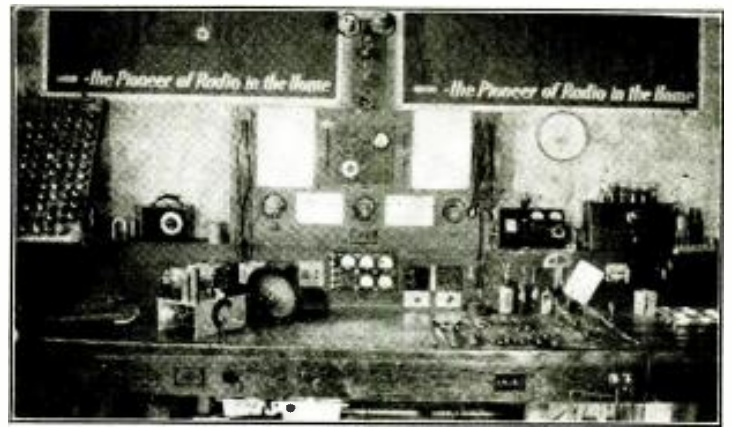

Fig. A

An efficient arrangement of a radio test-table.

der test is read directly from the scale of the variable resistor R1; this is a 250 ohm rheostat and it may be calibrated with fair accuracy—certainly within the limits set by other factors—by the simple process of dividing the arc which the indicator traverses into twenty-five equal portions. The constants of the bridge are such that each division on the scale (each ten ohms of resistance) will correspond to a mutual conductance of 100, and the scale should be thus calibrated from zero to 2500 (as shown at B).

The voltmeter has a range of from zero to 10 volts and may be any fairly accurate D.C. meter.

The method of operation is as follows: with the buzzer in operation and the tube in the socket, adjust the filament voltage to the correct amount by means of the rheostat. Now vary the calibrated rheostat until the minimum sound is heard, and read off the mutual conductance.

The tubes most likely to be tested are listed below together with their operating characteristics.

TABLE I

Tube Type	Fil. and	Volts Plate	Volts Grid	Volts S.G.	Mmhos Gm
'12	1.1	90	4.5		425
12-A	5	135	9		4600
71-A	5	180	40.5		1500
99	3.3	90	4.5		420
01-A	5	90	4.5		740
10	7.5	425	35		1600
22	3.3	135	1.5	45	350
24	2.3	180	1.5	75	1050
26	1.5	135	9.		1100
27	2.25	90	4.5		900
45	2.5	180	34.5		1800
50	7.5	450	84		1800
47	2.5	250	16.5	250	2500
30	2	90	4.5		700
31	2	135	22.5		760
32	2	135	3	67.5	505
35	2.5	180	1.5	75	1100
36	6.3	135	1.5	75	1100
37	6.3	135	9		900
38	6.3	135	13.5	135	900

The values of the parts shown are:

- Bz—One high-frequency buzzer;
- T—Transformer, about 1/1 ratio, such as used from single '71A output tube into a magnetic speaker;
- M—0-10 voltmeter;
- R1—250-ohm rheostat;

R2—100-ohm resistor, to carry relatively high current;

R3—1000 ohms;

No great care is necessary in the construction of the bridge; since, even with screen-grid tubes, the effective gain through the tube under test is not large enough to cause any appreciable feedback effect. The greatest amount of care will be required in the operation of the device: be certain that the switch is not in the "Screen-Grid" position when a three-electrode tube is being tested, and that the low-current rheostat is not employed with a tube drawing a high current.

No provision is made for checking the tubes to be tested for internal short circuits; so that a short-circuited tube introduced into the bridge circuit will result in the destruction of the 100-ohm rheostat, through which the short-circuited plate current will flow.

A PRACTICAL SERVICE BENCH

By Harry F. Sewell

THE complete and efficient service bench illustrated in Fig. 3 and shown in block form in Fig. 3 was constructed by the Tafel Electric Co. of Louisville, Ky. It was designed and built by the writer, over a period of two years.

The bench is of the ordinary type, being built of 2 x 12 in. wood, supported by 2 x 4 in. racks, and measures 13 ft. long. The panel-board at the rear of the bench is constructed of stripped 1/2-in. white pine, glued together, forming a sturdy unit on which to mount apparatus.

Panel mounting of all test equipment is preferred by the author. The equipment located on this panel is of the latest type, consisting of one General Radio type 360-A test oscillator; two ohmmeters, one having a range from 0-500 ohms and the second from 0-100,000 ohms (these, along with the 300 watt meter shown in the center of the panel, were built to the specifications of the writer by the Westinghouse Electric & Mfg. Co.); one type SG-1600 Hickok set analyzer, and; one type AC-47 Hickok mutual conductance tube tester. The balance of the testing equipment was built by the writer.

In the center of the bench at the top of the panel board is located a condenser test set, consisting of one neon lamp, one UX-874

(Continued on page 309)

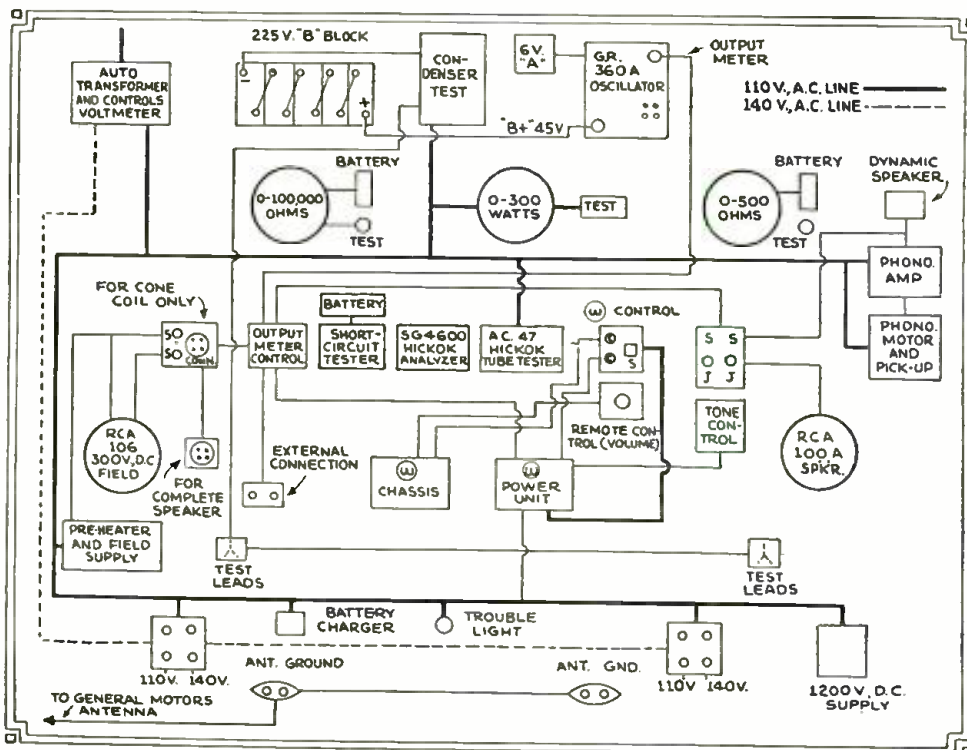

Fig. 3

A block diagram of Mr. Sewell's very complete service station arrangement. A wattmeter is included as part of the apparatus.

STROMBERG-CARLSON Nos. 19, 19-A, and 20 SUPERHETERODYNES

clarifier." A high-low switch in the primary circuit of the power transformer compensates for differences in line potential. The tuning condensers have a maximum ca-

Particular interest is attached to the Models 19 Lowby and 20 Highboy superheterodyne receivers produced by the Stromberg-Carlson Tel. Mfg. Co., in view of these being the first of this manufacture to incorporate the superheterodyne circuit. These receivers utilize the Model 19-A chassis.

Values for the components are given below:

- Resistors R1, R4, 500 ohms; R2, R6, 600 ohms; R3, R5, 6,500 ohms; R7, 10 meg.; R8, R13, (tone-control resistor) 0.1-meg.; R9, 30,000 ohms; R10, 400 ohms (hum balancer); R11, 750 ohms; R12, 10 ohms; R14, 60,000 ohms; R15, 1575 ohms; R16, 900 ohms; R17 (volume control), 1,000 ohms; R18, 60 ohms; R19, 3 ohms. Condensers C1, C2, C3, C4, tuning condensers, shunted by trimmers C2A, C3A and C4A; C5, C16, C20, 0.01-mf.; C6, C7, C8, C9, C10, I.F. transformer trimmers; C11, C26, .04-mf.; C12, input coupling condenser; C13, band selector coupling condenser; C14, C15, C17, C18, C19, C33, C34, 0.3-mf.; C21, .00025-mf.; C22, 0.6-mf.; C23, .002-mf.; C24, C25, C29, C30, 2 mf.; C27, 1. mf.; C27A, C28, C29A, 3 mf.; C31, C32, .01-mf.

The intermediate frequency is 175 kc. This receiver includes a band-selector preceding the first R.F. tube; a capacity network in the oscillator circuit to maintain correct gauging of the tuned circuits; a hum-balancer (resistor R10); tone-control; phonograph pickup connections; tuned filter-choke arrangement; line pick-up noise eliminator (Condensers C31, C32); and power-type second-detector (although a grid-leak and condenser are shown, the circuit operation is of the "plate rectification" type). The tone-control is called an "automatic

volts; V7, V8 (plate to center-tap of R10), 250 volts. Control-grid potential (control-grid to cathode), V1, V4, V5, 3 volts; V2, V11 volts; V3 (across R5), 12.5 volts; V6 (across R9), 22.5 volts; V7, V8 (control-grid to center-tap of R10), 47.5 volts. Screen-grid potential, V1, V2, V4, V5 (screen-grid to chassis), 85 volts.

In Stromberg-Carlson literature the first-detector is called the modulator, and the second-detector is called the demodulator. The resistors in these receivers employ the RMA color code.

It may be found that in some instances the magnetic pickup control switch is forced into its operating position (normally obtained only by fully retarding the volume control). Readjust by moving the pickup switch to its normal setting.

Do not test the chassis without the reproducer properly connected to it. Either the reproducer should be removed with the chassis, or the Service Man should provide himself with a four-conductor extension cord which will connect the reproducer connector plug to the connector socket in the rear of the chassis. Because of the high voltage of the circuit in which this item must be used, it is essential that the insulation be adequate to meet the demands of the filter supply.

Due to the use of a band-selector in the R.F. input circuit, it will be observed that the reproducer will have a "flat top" characteristic. The gain of the Model 19-A chassis is exceptional; consequently, it should be possible in most instances to operate the receiver for satisfactory local reception using for an antenna only such metal-work (lathing, etc.) as may exist in the building.

The schematic circuit of the Model 19-A is shown below.

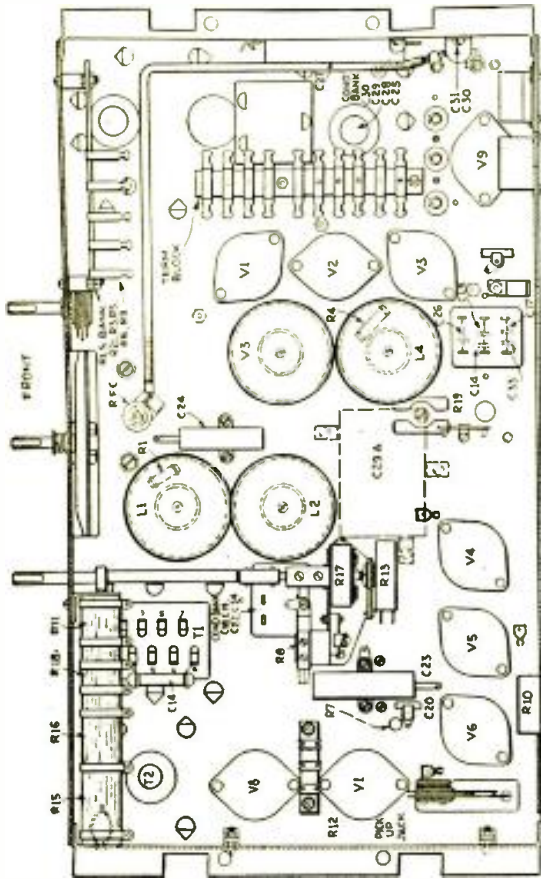

Arrangement of parts on the underside of the new 19- and 20-series chassis. The reference numbers do not coincide with those in the Stromberg-Carlson manual, for this receiver, but correspond with the indicia in the schematic circuit, below.

- 5, V6, V7, V8, 2.4 volts; V9, 4.8 volts. Plate potential (plate to chassis), V1, V2, V4, V5, 160 volts; V3, 87 volts; V6, 202 volts.
- The tone-control, and phonograph switch J-S are combined in one unit.

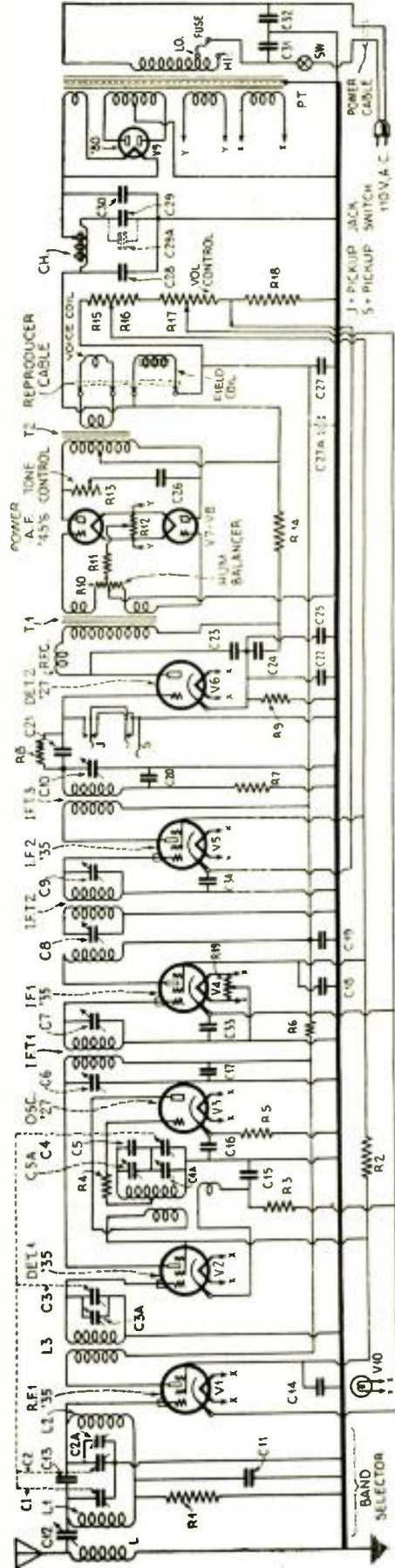

Schematic circuit of the Stromberg-Carlson 9-tube superheterodyne radio set. This is the chassis for the Models 19, 19-A, and 20 receivers. The input circuit is preceded by a band-selector. The oscillator output couples into the cathode of the first-detector (or "modulator") tube, 1-2.

RCA VICTOR "MODEL R-43" CONSOLE

Also General Electric Model "G. E. S-42B" Battery Console

Although numerous "Aircell"-type radio receivers have appeared on the market (See the April, 1931, and subsequent issues of RADIO-CRAFT), the Model R-43 receiver is the first one offered by RCA-Victor. As the schematic circuit indicates, a superheterodyne circuit is

employed. In this chassis are used three screen-grid, 2-volt type '32 tubes, and five general-purpose, 2-volt type '30 tubes.

The following values are used for the resistors and condensers used in this receiver:

Resistor R1 (volume-control potentiometer), 50,000 ohms; R2, R4, 6,000 ohms; R3, 15 ohms; R5, 29,000 ohms; R6, 4,000 ohms; R7, 40,000 ohms; R8, R14, 180,000 ohms; R9, 270,000 ohms; R10, R11, 350,000 ohms; R12, R13, 1 meg.; R15, 50,000 ohms (variable); R16, 1,300 ohms; R17, 650 ohms; R18, 8 ohms.

Condensers C1, C2, C3 (tuning units), 18 to 325 mmf.; C1A, C2A, C3A (tuning trimmers), 4 to 50 mmf.; C4, 745 mmf.; C4A (C3 trimmer), 15 to 75 mmf.; C (I.F.T. trimmers), 15 to 75 mmf.; C10 (I.F.T. trimmers), 140 to 220 mmf.; C5, 745 mmf.; C6, C7, C11, 0.25-mf.; C8, 0.5-mf.; C9, C12, C14, C18, 0.1-mf.; C13, 1. mf.; C15, C16, .0012-mf.; C17, .0025-mf.; C19, .0024-mf.

Operating potentials are as follows:

All filaments, 2. volts. The remaining figures are to be read with the volume control set at minimum; voltages are read with respect to the filament. Control-grid potential, V1, V4, 22 volts; V3, 0.5-volt; V5, 5 volts; V6, 2 volts; V7, V8, 15 volts. Screen-grid potential V1, V5, 55 volts; V3, 65 volts. Plate potential, V1, V5, 155 volts; V2, 50 volts; V3, V6, V7, V8, 150 volts; V5, 90 volts. Plate current, V1, V4, V5, zero; V2, 3 ma.; V3, V7, V8, 0.5-ma.; V6, 2.5 ma.

With the volume control set at maximum,

the following new readings will be noted: Control-grid potential, V1, V4, 1.5 volts. Screen-grid potential, V1, V4, 55 volts; V3, 60 volts. Plate potential, V1, V4, 155 volts. Plate current, V1, V4, 2.5 ma.

The total high-voltage-battery drain of this receiver is only 8 to 15 ma. The "A" drain is only 0.48-amp.; or a battery life of 1200 operating hours.

The precautions, mentioned in the issue of RADIO-CRAFT referred to above, concerning the correct use of the Aircell type of "A" supply, must be observed. Note particularly that this type of battery must not be operated at temperatures below 40 deg. F.; consequently, if it is essential to install one of these sets where operation necessarily might be required at this temperature, it will be necessary to substitute a different type of "A" supply,—for instance, a 2-volt storage-cell. This cell will not require frequent charging, due to the low filament drain of the receiver.

The tubes of the push-pull power output stage are biased to substantially plate current cut-off. The arrangement is such that the output stage may deliver substantially four times the output that would be obtained with the same tubes operated in the usual circuit. This system is very economical, due to there being but a small amount of residual plate current flowing in the output stage. Current is drawn only when a modulated signal is received.

The purpose of the extra secondary (shunted by condenser C19) on output transformer T2, is to provide a fixed high-frequency cut-off for the audio amplifier.

The tone control consists of a 0.1-mf. fixed condenser C18 and 50,000 ohm variable resistor R15, in series, connected across one side of the input grid circuit of the push-pull stage.

Due to the fact that the aircell must not be overloaded (as, for instance, by shorting, or testing with a low-resistance test instrument), there has been no attempt to obtain reproducer field current from the "A" circuit; instead, this field is obtained from a powerful permanent magnet. Many previous 2-volt-tube set models incorporated "inductor-dynamic" reproducers; but the Model 43 instrument uses a "magneto-dynamic" loudspeaker.

For more detailed information concerning the balancing of the oscillator, the R.F., and the I.F. circuits, reference may be made to the service information concerning a chassis which in these respects is similar—Radiola "Superette" Model R7 (Data Sheet No. 47; August, 1931 RADIO-CRAFT).

Erratic operation may be due to low "B" batteries; replace these units when their output potential has dropped 25% when under normal load.

A peculiarity which at first may not be clear will be observed in the diagram. This is the positive 22½ volts connection. This is the 22½ volt tap nearest the "B" minus tap on the first 45-volt "B" block.



Arrangement of parts (rear view) in the new Radiola battery-operated 8-tube superheterodyne.

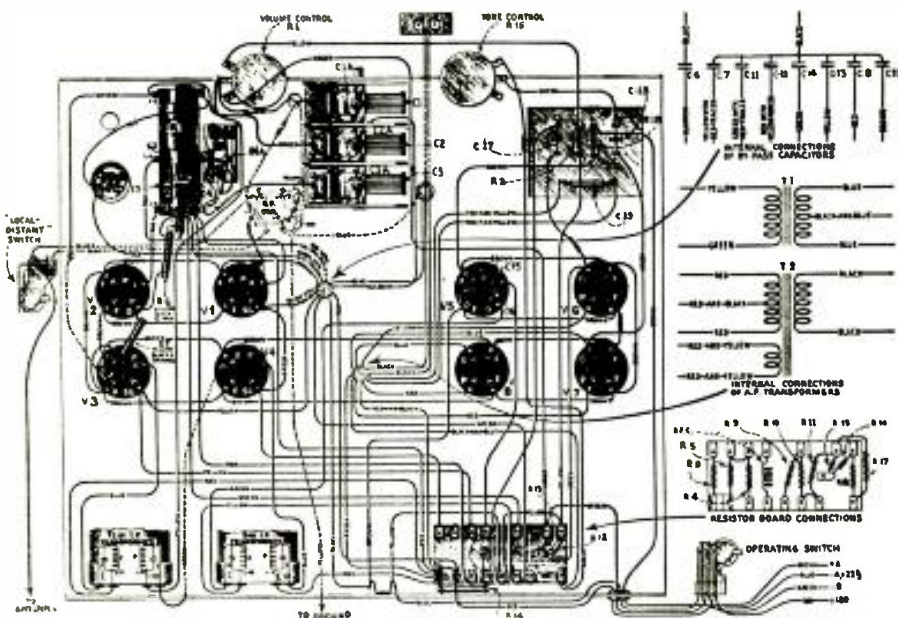

Wiring diagram of the new "self-contained" Radiola model. Electrical values for the components appear in the text.

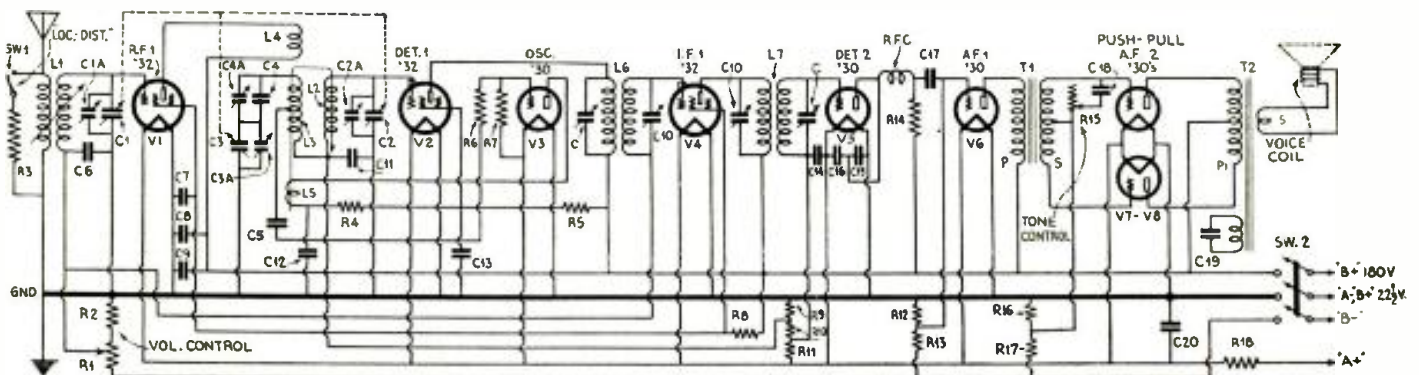

Schematic circuit of the Radiola Model R-43 receiver, which incorporates an unusual arrangement of the oscillator circuit. In addition to the usual padding-condenser connection, there is a center-tap lead to a coil inductively-coupled to the grid coil of the first-detector, affording input to the oscillator grid circuit, through C5.

Operating Notes

By and for the Practical Radio Service Man

SERVICING SPARTONS, BRUNSWICKS, AND MAJESTICS

By Bertram M. Freed

A COMMON complaint on many Sparton model "600," "610," "620" and "737" (the same chassis is used in all these types) and "740" receivers (since the "595" output tube is the same as the "50" tube) receivers is lack of control of volume. These models are similar to all late Sparton's except for an additional tuned R.F. stage located in the band pass tuner assembly as shown in Fig. 1.

At the base of the socket for this tube, beneath the shield, will be found a 0.2-uf. condenser, which is used to bypass the cathode bias resistor network of which the volume control, resistor R1, is a part. When this condenser unit becomes shorted, the set operates at full volume because the bias resistor is shorted. This same unit is often the cause of intermittent or fading reception, where it opens or short circuits.

In order to enable the installer or repairman easy access to the sets, the different units comprising the chassis are mounted on a board which slides back from the cabinet. The volume control is mounted on a metal panel which is fastened to this same board. When the board is pushed back into place, the panel is forced back about 1/4-in., often shorting the volume control lugs to the R.F. amplifier assembly.

The manufacturers of Sparton receivers have been turning out two model "737" receivers. The only visual differences between the two lie in the chassis color, and the power transformer and push-pull input audio transformer design. One model is sprayed in gold while the other is colored black.

The "black" model employs a power transformer originally designed for their old "301" model, using two '81 rectifiers, and two '50 power tubes. The filament voltage has been cut down to five volts to heat the single '80 and the pair of 183 power tubes by means of resistors in each filament leg. The high voltage output has been decreased by the addition of a large 1200-ohm resistor which is located alongside the '80 rectifier.

The cause of many inoperative "black" receivers will be found in an open resistor labeled "1200 ohms." For some reason or other, this "301" transformer, designed for heavier use does not stand the gaff. Perhaps a hundred of these units have had to be replaced because of shorted primary or high-voltage-secondary windings. When "no filament" is obtained on the '80 or 183 tubes, look to open step-down resistors.

The audio transformer in the "black" job is a Pacent, and is so closely mounted to the 183 tube next to it that the tube cannot

fit securely into its socket, being forced to one side. Another hole should be drilled in the metal chassis so that the transformer can be shifted to one side a bit.

In the Sparton 400 midget chassis series, an annoying condition is often found that was at first difficult to trace. Recently one of these receivers was returned to a repair shop with an R.F. plate-to-chassis short. The several bypass condensers were checked but found perfect; as well as the common "B+" terminal located beneath the chassis, which is insulated from the chassis by means of two insulating washers that sometimes shift. All leads (in the R.F. circuits) were tested by unsoldering them from their respective lugs and terminals. It was not until this had been done that the short was located.

This set used red, shielded leads to connect the plates of the type '24 tubes to the R.F. coils. The insulation on these leads is poor and breaks down within the shield, causing the wire to short to the grounded shield. A heavy insulated, unshielded lead was installed to replace the defective shielded wire. These leads are indicated by X1 and X2, Fig. 2.

Noisy reception in these receivers has often been traced to dust and small foreign particles between the condenser-gang plates, which are very close together—thus making

a condition such as this quite common.

The Brunswick models "14," "21" and "31" receivers employ a tuning-drive-cable arrangement that is far superior to many other systems—in which forcing the tuning knob beyond either end of the scale may snap the drive cable. This is impossible in the Brunswick receivers due to the use of a small friction gear over which the cord passes; turning the tuning knob beyond the tuning range only causing the gear to slip around. However, cases may be found where the knob can be turned without the consequent actuation of the condenser gang. Almost invariably, this is caused by a loose cord, which may be taken up by increasing the tension of the spring located on the side of the dial. The spring is attached to the free end of the drive cord on one end, and fastens to a screw on the other. This screw is in a slotted hole, permitting it to be shifted so as to increase or decrease the spring tension. After the unnecessary slack has been taken up, the screw may be tightened.

Noisy and intermittent reception on these models has often been caused by a defective local-distance switch, the blades of which become loose after some use. The remedy is usually found in replacement; though, tightening the screws holding the blades has sometimes cleared up the difficulty.

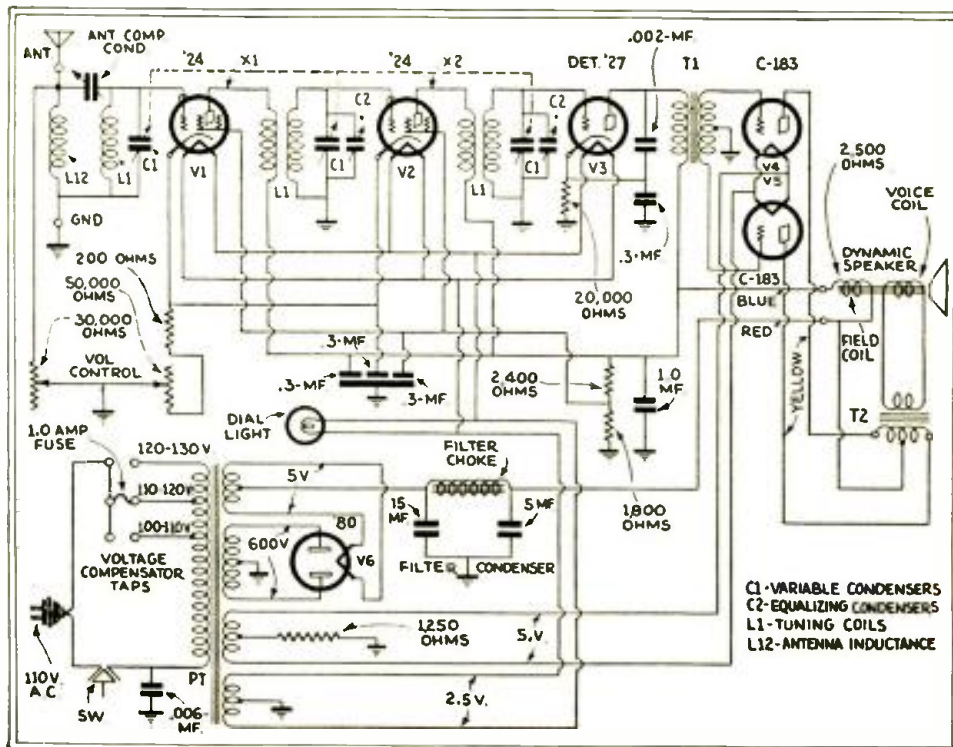

Fig. 2

Schematic diagram of the Sparton "400" receiver. Shielded plate leads X1 and X2 were replaced with heavily insulated, unshielded leads to prevent short-circuits to ground.

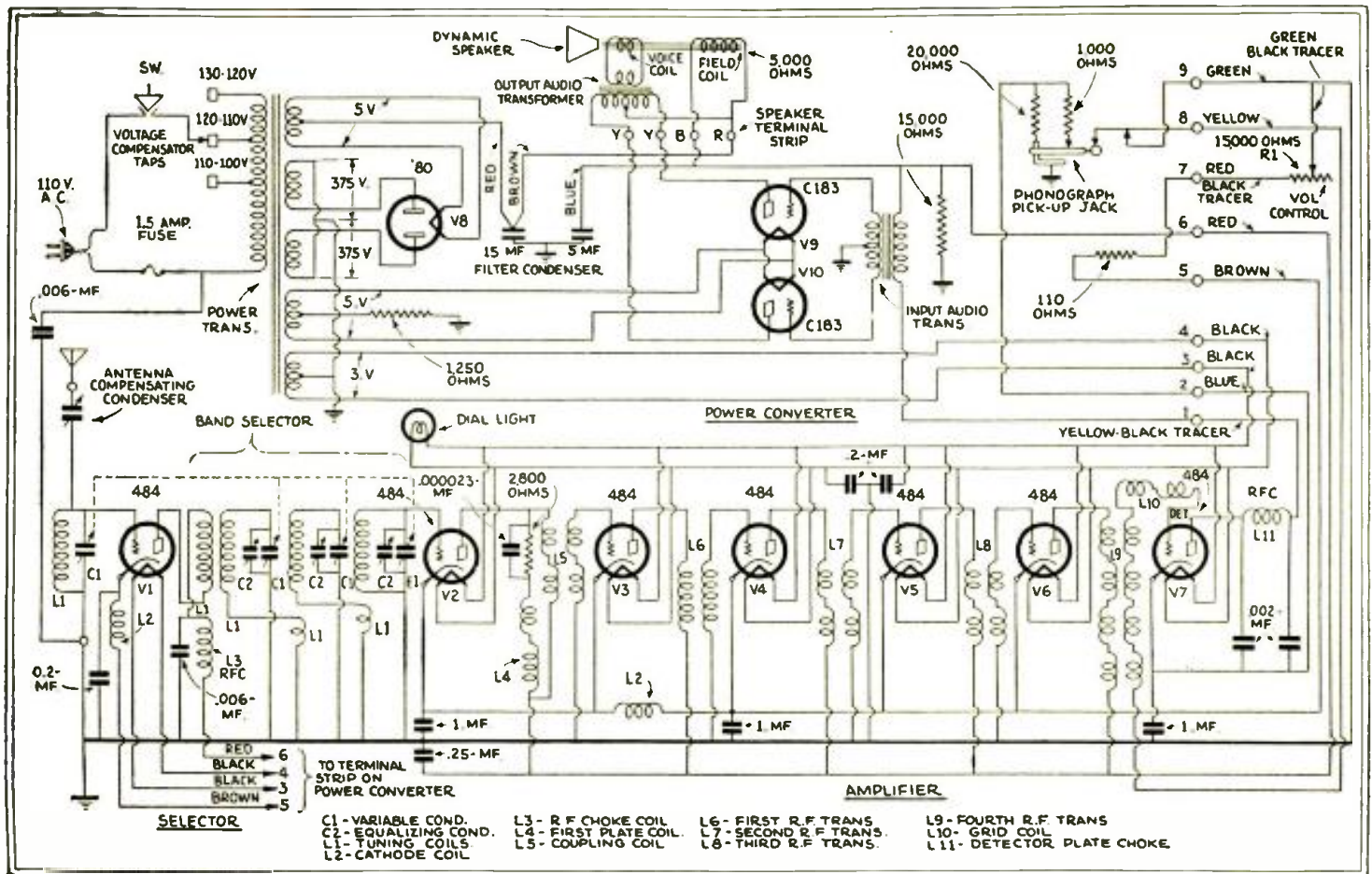

Fig. 1. The Sparton Models "60", "610" and "737" receivers. A common complaint, lack of volume control, may be due to a shorted 0.2-mf.

A large number of Bosch "28" and "29" receivers, lately, have showed up with the common complaint of "noisy reception." Several of these were taken to the repair shop to determine the cause of the trouble. The type '26 tubes were each, in turn, pulled out of the circuit starting with the 1st R.F. stage, but, with the exception of two sets, the noise continued. When the '27 detector tube was removed, about 75% of the noise disappeared in all except one case.

After a new and perfect first A.F. transformer had been installed in place of the one in the set, the noise cleared up in all except three sets. One had a very noisy carbon volume control that made a racket even though the control was not touched! When a new volume control was put in, that set was in perfect shape. The remaining two receivers caused quite a bit of trouble. The grid-leak and grid-condenser were changed with no change in results. Finally, the detector plate 50,000 ohm "glastor" resistor was replaced, and the noisy condition cleared up. Some sets needed both the transformer and the resistor replacements, before the complaint was settled.

For sharp tuning in the first R.F. stage, these same models use a variometer that is often the source of varying volume, or "fading." Reception will be normal for a time and then drop in volume, necessitating a re-adjustment of the volume control. After several minutes, reception will become "normal" once more. Upon examination, a black lead will be disclosed, connected to one side of the stator of the variometer. This lead passes through a hole in the chassis and continues on to the other side. Vibration causes the metal chassis to bite through

the insulation of the lead at the hole, for the lead is drawn quite taut, and causes the annoying condition of fading. A heavily insulated lead, additionally protected where it passes through the hole, should be used to replace the old lead.

A great deal has been spoken about the Majestic "60" series superheterodynes. The first batch of these sets that were placed upon the market were wired with some highly absorbent cotton covered leads. The slightest bit of moisture was enough to throw the set out of balance. Several resistors used were affected in the same way. In some sets the tuning meter would become inoperative; in others, very erratic. The main trouble however was a very weak, or even inoperative, receiver. These sets can be rewired according to the extensive, detailed data supplied by Grigsby-Grunow; or sent to the nearest distributor of Majestic receivers, who should make the necessary changes without charge.

THE RADIO FIREMAN

IN the little Dutch village of Jutphaas, near Utrecht, a system of wired radio has been installed in order to transmit calls to members of the local fire brigade. Special radio receivers are linked up with the fire alarms; they are so designed that when the latter are pulled automatic Morse signals consisting of five letters are simultaneously transmitted to the home of every fire-fighter. These letter-calls vary according to the district in which the outbreak has taken place. —Amateur Wireless.

UNUSUAL INTERFERENCE SOURCES
By William Murrills

IN A small Western city several interesting cases of radio interference have been discovered. In one instance a set owner complained that at certain times of the day it was impossible to use the radio because of the interference. The power company then traced the interference to the point where the noise was loudest; this led them to a cable entering the local telephone company's office. At the time of the test, none of the electrical machinery of the plant was in operation and the main switch was open so that all lines were dead. It was almost certain, therefore, that the source of interference was not in the building. To make sure, however, a test was made. When the test equipment was placed on top of the generator, only a faint noise was heard; while on the floor right next to the machine no noise whatever was audible. Upon further investigation, it was found that the particular cable in question contained a wire leading to a switch in the office, from which a police light on the main street was operated as a courtesy to the city. When this switch was opened, the noise completely died out. It was evident, then, that some high-frequency current was being picked up and carried along the wire to a point near the aerial leading to the receiving set of the complaining set owner.

The city, upon being told that the police light was causing interference in nearby radios, decided to discontinue the operation of the light rather than go to the trouble and cost of locating the interference source. (Continued on page 303)

Recording Amplifiers

The subject of instantaneous sound recording consequently, our readers

By GEORGE

THE advisability of using high gain audio amplifiers to insure the production of good home records has been repeatedly pointed out in these articles. It is now my purpose to discuss in detail the different types of amplifiers that can be used.

The recording level required for instantaneous or "home" recording is much higher than that required for commercial wax recording; the cutting stylus in the latter case having very little mechanical work to do against the wax disc and, consequently, the required level is only about +3DB. In making instantaneous records, however, the cutting stylus, besides modulating the track, must compress the material of which the record is made. This compression must be effected by weighting the cutting head with a fairly heavy weight, and naturally the modulating action of the stylus is retarded considerably. As a result, the gain of the amplifier feeding the cutting stylus has to be quite high if a loud record is desired.

Aluminum records are made at a level of between +15 to +20DB, and since the output level of a carbon microphone is about -36 DB, the gain of the recording amplifier must be at least +51DB. Ungrooved celluloid records, due to their greater hardness, require a higher recording volume level than aluminum records, or about +25 to +30DB. It is obvious, therefore, that the amplifier gain should be at least +61 DB. The recording level for pre-grooved celluloid or aluminum records is the same.

It is desirable for two reasons that the amplifier have more gain than is really needed. First, high gain affords extreme freedom of position about the microphone:

that is, the person or persons being recorded may be located at a greater distance from the microphone than ordinarily, and still obtain a good recording. Secondly, high gain makes it unnecessary that the microphone, in order to increase its sensitivity, be operated at the high current value, which results in strong background noise.

The "direct-coupled" amplifier is considered one of the most faithful from the point of view of frequency response, and it makes an excellent amplifier for use with pre-grooved celluloid or aluminum records. (Diagrams of direct-coupled amplifiers have appeared in past issues of RADIO-CRAFT.)

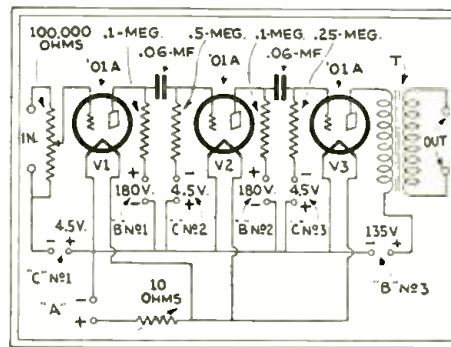

Fig. 1

A resistance-coupled amplifier, having a flat characteristic, which is suitable for recording.

The disadvantage is that the gain with respect to the microphone is comparatively low. There is very little mobility allowed around the microphone, and since the latter thus has to be operated at full current value, to increase its sensitivity, the chances of microphone noise are increased.

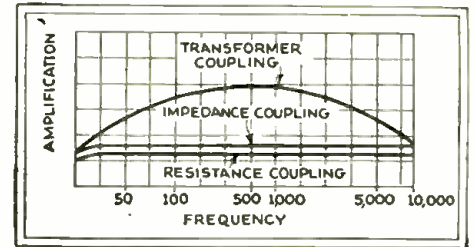

Fig. 3

Frequency versus amplification characteristics of three types of A.F. amplifiers.

An amplifier using resistance coupling has a relatively flatter characteristic than either impedance or transformer coupling, but the gain in this type of amplifier is low, due to the fact that the only amplification is that derived from the "mu" of the tube; at best, only about 75% of the "mu" being obtained.

The circuit of such an amplifier is shown in Fig. 1. It should be noticed that separate "B" and "C" batteries are used in each stage. This is done to minimize inter-stage coupling, reduce external noise, reduce pickup, etc. It must be realized that all extraneous noises will be superimposed on the record. Any precautions that would tend to reduce these extraneous signals should be taken.

A.F. Amplifiers

The principal advantages of resistance coupling are: (A), flat frequency characteristic up to moderately high frequencies; (B), absence of all resonance peaks; (C), lightness and compactness of units, and; (D), low cost of units.

The most important disadvantage of this type of coupling is the high "B" voltage required due to the large voltage drop in the plate resistor.

So called "impedance coupled" amplifiers use an inductance instead of a resistance in the plate circuit. The gain is approximately the same as in resistance coupling, but less "B" voltage is required, due to the lower D.C. resistance of the choke.

The gain can be increased by the use of higher-mu tubes, but more care in design is required to avoid such difficulties as the following: (A), loss in amplification at low frequencies due to the use of too low an impedance choke coil, and; (B); resonant points and excessive amplification, or even circuit oscillation, at frequencies between 100 and 300 cycles, a condition which may be brought about through the combined action of the high effective tube input capacity and the inductive reactance of the coupling impedance.

The "transformer-coupled" amplifier is, in the opinion of the writer, the best type for recording. In the first place, it gives

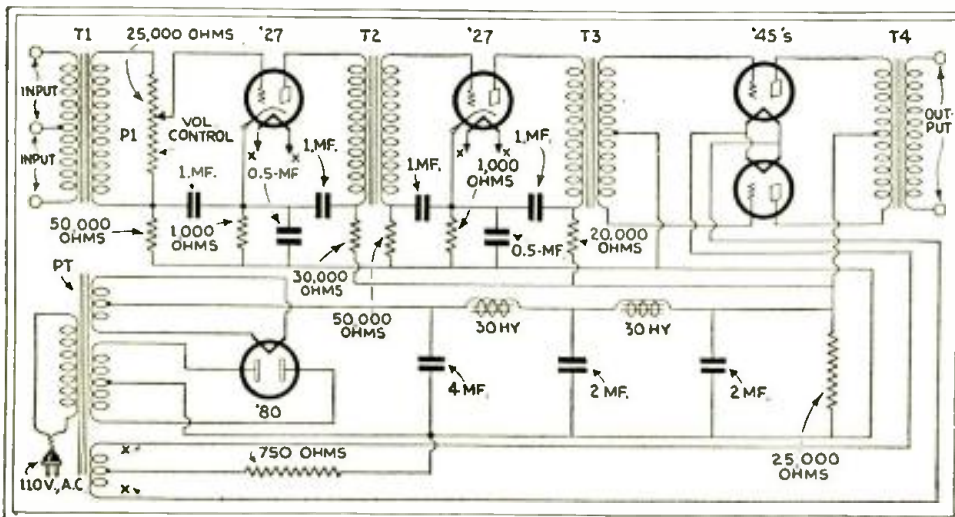

Fig. 2

The final amplifier selected by the author for recording purposes. The very thorough by-passing makes for extreme stability of operation.

and Level Indicators

has created a great deal of interest; will welcome this discussion.

J. SALIBA, S.B.

the most amplification for a given investment. Using three transformer-coupled stages, Fig. 2, the gain is approximately 70 DB, which is more than enough for good recording.

In this type of amplifier the "B" voltage may be comparatively low; and high-mu tubes are not necessary. The signal voltage besides being amplified in the tube is also stepped up in the transformer. The amplifier is very stable with hardly any chance of oscillation. The frequency characteristic (closely approximated in Fig. 3) is not as flat as that of the resistance- or impedance-

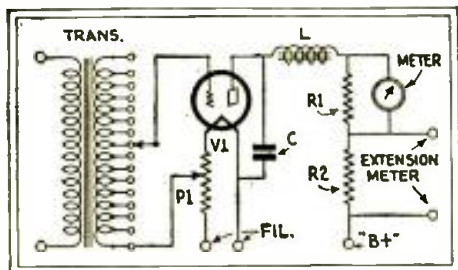

Fig. 4

A diagram of a commercial volume indicator.

coupled amplifier, but it can be improved considerably by connecting a variable resistor of 100,000 ohms, maximum resistance, across the secondary of each transformer, and adjusting them for best results.

The writer has had considerable success with the amplifier shown in Fig. 2, its quality and stability recommending it for police recording in crime detection (described in the July, 1931, issue of *RADIO-CRAFT*). Using "Saugamo" transformers the gain was such that recording was possible with the subject 15 to 20 feet from the microphone.

Level Indicators

Strange as it may seem, the "level indicator," which is very essential for good recording, is in very little use. It is not hard to build; and, even if purchased, the slight cost is more than offset by the insurance of good records at all times.

Heretofore, it has been the custom to test the level at the cutting stylus by means of a "monitor" speaker; or, if the microphone happened to be in the same room with the machine, by means of feeling the stylus with the finger! At best, either of these methods is a guess.

A level indicator, in reality, is nothing more than an ordinary vacuum-tube or "V.T." voltmeter, which operates on the principle of the vacuum tube detector. In an amplifier, the vacuum tube must be worked on the "straight" portion of its characteristic (point b, Fig. 5) so as to maintain the linear ratio of input voltage to output power, which is required for undistorted power output; while in the V.T.,

voltmeter the tube is worked on the curved "heel" of the characteristic (point a, Fig. 5) so as to obtain the distorted output shown in the figure.

The circuit of a commercial level indicator is shown in Fig. 4. An A.C. flowing through the primary of the input transformer will cause an alternating voltage drop across it; and by induction, an increased voltage drop will appear on the secondary side. A portion of this secondary voltage is applied between the grid and filament of the tube. This voltage alternately adds to, and subtracts from, the D.C. grid bias.

Since the tube is operated on the curved heel of its characteristic the plate-current-change that corresponds to the grid-voltage-change will be distorted, and the average plate current drawn by the tube thus will be higher when an A.C. potential is applied to the grid, than if the grid had only the D.C. bias.

In order to smooth out the fluctuations of current in the meter circuit, but still permit the meter to register most of the current peaks, a condenser C and an inductance L are connected in the circuit as shown in Fig. 4. Damping for the meter is provided by the resistance R1 shunted across it. It is evident, therefore, that the combined damping action of the tube and the plate circuit filter causes the needle of the meter to deflect for groups of plate current fluctuations. If the needle was permitted to follow each individual plate current fluctuation it would be extremely difficult to follow the rapid, erratic movements of the needle.

Figure 6 shows the circuit of a level indicator that can be easily built at home, and while not as elaborate as the commercial type it is quite accurate enough for home recording. The meter used is an ordinary D.C. milliammeter with a 0-5 scale; damping is provided by the condenser C shunted across the meter. Since the battery will drop in voltage due to use, the 10,000 ohm potentiometer P2 is provided to afford con-

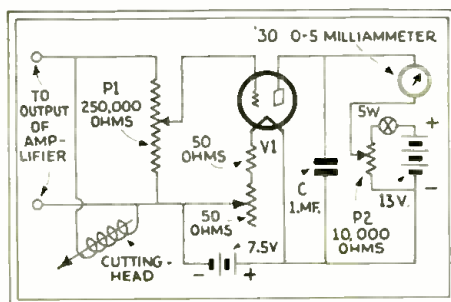

Fig. 6

A volume indicator circuit for the home constructor.

control over this voltage,—since it is very important that the filament and the plate voltages remain constant. From time to time the battery voltages should be checked.

The level that is necessary for good records of each type of record is best determined by test (of course, this figure was only roughly approximated in the values
(Continued on page 314)

A PORTABLE RADIO PROGRAM RECORDER

OWNERS and operators of broadcast stations, who in the past have been violating minor rules and regulations of the Federal Radio Commission, and have been evading the long arm of the law, are now watching station operation very carefully, especially since the installation of a new radio program recorder, Fig. A.

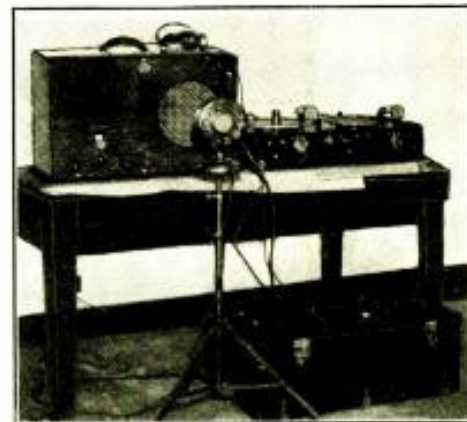

Fig. A

The Federal Radio Commission's "evidence" of broadcast infractions. (Illustration, courtesy RCA-Photophone, Inc.)

The apparatus, recently demonstrated before officials of the Federal Radio Commission, was designed by RCA-Photophone, Inc.; and consists of a recorder containing two motor-driven turntables, a recording amplifier, a microphone, a radio receiver and a loudspeaker. Pre-grooved blank disc records are placed upon each of the twin turntables and when in operation, with sound being recorded as it emanates from the loudspeaker, these records operate continuously, automatically changing from one to another.

Heretofore, the commission has been forced to depend almost entirely on stenographic records, which have in the past proved unsatisfactory. With this new device it is possible to have an absolutely perfect record, which, if needs be, can be introduced before the Commission's examiners.

The portability of the apparatus makes it possible to carry it to remote places.

THE "TROPIC SHORT-WAVE "SUPER

Many short-wave superheterodynes have made their appearance in the radio field, but Tropics. The receiver described by the author has been designed with a view toward and dampness.

By GEORGE

BUILD me a radio set for use in the Tropics." These few words sounded innocuous enough some months ago when a representative of the U. S. Consular Service in New York addressed them to the writer. Not realizing, however, that this would eventually prove to be an outstanding example of the folly of wisdom, I blithely accepted the job.

After about ten minutes of friendly grilling, I was almost convinced that I had picked a "lemon," but being blessed (?) with a generous portion of Welsh stubbornness it wasn't very long before I began to formulate a plan of attack pointing toward a successful solution of the problem.

However, before we consider the design of the receiver finally used, it will be well to picture radio reception conditions which exist in the torrid belt between the Tropics of Cancer and Capricorn.

If the set constructor will bear with us during this short interview, we promise to divulge some interesting information, the possession of which may indicate to more than one technician just *why* some one of his radio installations, though in a more mild climate, is not working "according to Hoyle."

Tropical Limitations

During the summer months static is a daily, and sometimes all day affair so that for a radio receiver to be really useful, *reception below 50 meters is essential*. Another thing,—the set must possess a reasonable degree of selectivity (which greatly in-

creases the signal-to-static ratio), and a tone control (this latter refinement is necessary, since static is essentially of a high frequency nature, and the cut-off effect of a low-frequency-pass tone control further reduces the interference).

One very great obstacle is the damp, tropical atmosphere (near the coast it is heavily laden with salt) that effects the operation of power transformers available in the United States. Very few of them would operate for more than six months, due not only to the condition of the air, but also to the heat generated in operation at 25 cycles (the almost universal commercial frequency in South America), and the fact that sometimes they are subjected to an external temperature of 115 degrees Fahrenheit.

This temperature is equally disastrous to other components; condensers impregnated with pitch or wax, carbon resistors (unless specially treated), the fine windings of L.F. transformers, and all aluminum parts, fall a victim to this heat and the prevailing dampness. It may be stated in passing that aluminum of 1/12-gauge will crumble to a gray-white powder in three months or less.

As mentioned before, long-wave reception (our broadcast band of 200 to 550 meters, for instance) is out of the question during the greater part of the year, so that short-wave transmission from stations many miles away must be relied upon. Those of us who are familiar with short waves will appreciate the fact that reception from a near, local station is the exception rather than the rule, due to the skip-distance effect; and even

the best of the distant stations are received none too regularly.

People in the tropics, although they depend upon short waves for their entertainment, are not short-wave fans, and object to plug-in coils and the critical controls common to the regenerative set. As for head-phone reception, well, that's out. The obvious solution to this problem is a superheterodyne; the set and circuit eventually evolved as the best one is shown in Figs. A and I.

Circuit Design

There is really nothing outstanding in the design. Complications were avoided as far as possible, although considerable care was taken in the design of the power supply, the output of which is well filtered to smooth out the fluctuations of the notoriously bad power lines "down there."

A stage of resistance-coupled audio was used after the second-detector. This, together with push-pull pentodes, assures of loudspeaker reception.

A *tuned* R.F. stage ahead of the detector would have been better, increasing the sensitivity a little bit, but it would have introduced objectionable switching complications; so it was decided to leave this circuit untuned, and to couple it very loosely to the detector.

The set was assembled on a chassis which in its completed form measured 22 1/4 x 11 1/2 in. wide. Monelmetal, an alloy of copper and nickel, is ideal for the purpose, since

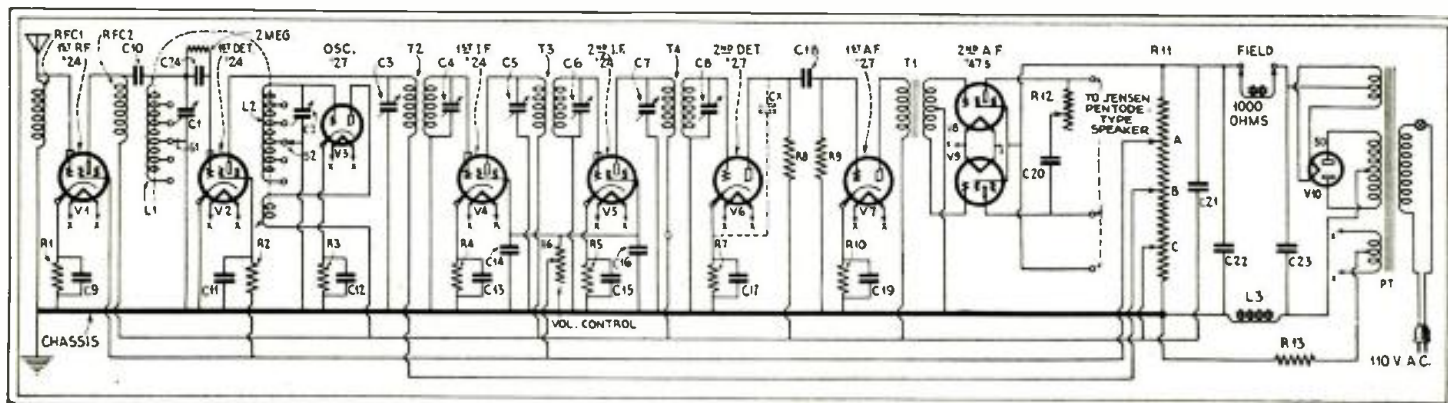

Fig. 1

Schematic circuit of the "Tropic 10" Short-wave Superheterodyne designed by Mr. Brooks. The first-detector and oscillator tap switches are mounted on the same shaft.

10'' -HET''

very few are suitable for use in the reducing static and withstanding the heat

BROOKS

it is both non-corrosive and an efficient shielding medium.

Construction Details

A sheet of this metal measuring 28 x 17 in. is required for the chassis. It is bent 3 in. on the front and back; then 3½ in. at the ends, and turned out ½-in. to form a "foot," as shown in Fig. 2.

While the writer has all the tools necessary to the trade, including a circle cutter for the 1/8-in. and 13/8-in. holes, it was de-

Fig. A
The "Tropic 10" S-H,
"Superhet."

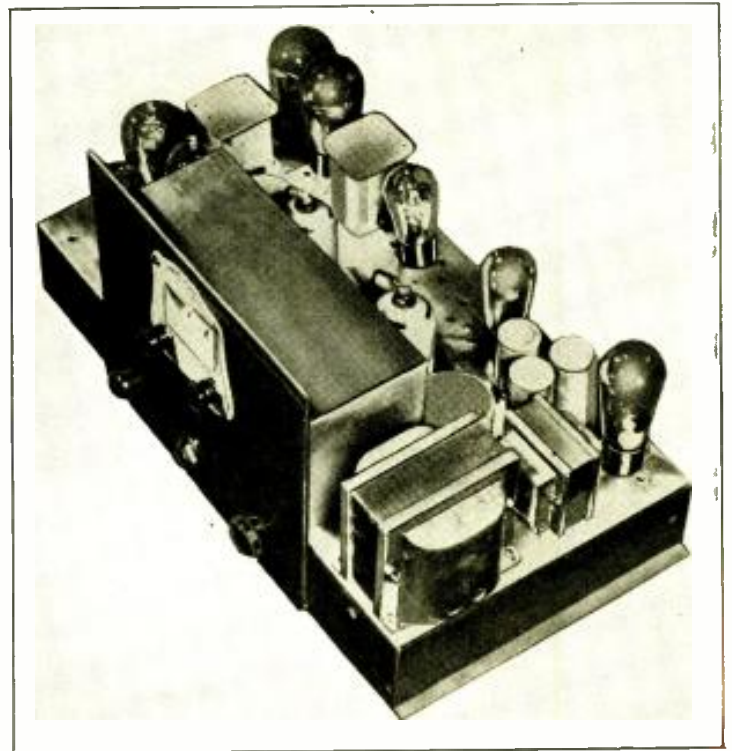

rier waves on this set.

On the contrary, there was considerable static, yet when a carrier was tuned in "on the nose," the static mysteriously disappeared, and the station came in clearly (or with a minimum of interference).

- 1 Lafayette 60 H. filter choke, L3;
- 1 Pilot double drum dial;
- 3 Amusco "450 kc." I.F. transformers, T2, T3, T4;
- 2 Amusco .00015-mf. S.L.F. variable condensers, C1, C2;
- 1 Electrad 15,000 ohm, 50 watt voltage divider, R11;
- 1 25-cycle Lafayette power transformer, PT;
- 1 Best double-pole rotary switch, S1, S2;
- 2 Carter 0.5-meg. variable resistors, R6, R12;
- 10 .01-mf. Dubilier fixed condensers, C9, C10, C11, C12, C13, C14, C15, C16, C17, C18, C19;
- 6 100 mmf. Hammarlund variable condensers, C3, C4, C5, C6, C7, C8;
- 2 60-mhy. R.F. chokes;
- 1 0.5-meg. Lynch resistor, R9;
- 1 "metallized" 80,000 ohm resistor, R8;
- 1 20,000 ohm carbon resistor, R10;
- 6 250 ohm Ward Leonard resistors, R1, R2, R3, R4, R5, R7;

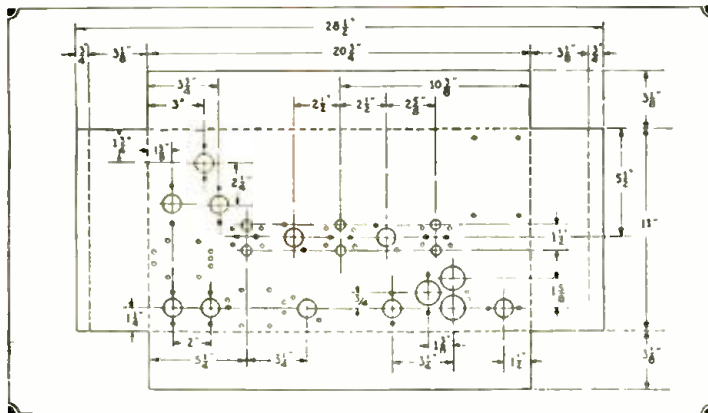

Fig. 2
Location and sizes of the holes in the monometal chassis.

ecided to use common, ordinary tools as often as possible. First, the 3/8-in. holes were drilled and then reamed out to the required size. Three experimental chassis were made this way, each with 13 holes of this size. Since the writer still is in good health it will be realized that monometal is not difficult to "work."

Particular care was taken to prevent pick-up of long-wave signals through the I.F. transformers. For this reason the leads from these units to the respective tubes were made less than 1 in. in length; shielding of these leads eliminating the last possibility of pickup, and at the same time, helping greatly to reduce inter-stage feed-back.

No provision was made for the reception of C.W. (continuous wave) signals. The set is primarily a broadcast receiver, although code stations can be heard if carrier modulation happens to be present on the same wave as the C.W. signal.

Contrary to the experience of others who have operated short-wave superheterodynes, there was no uncanny silence between ear-

In order to cover the ranges from 25 to 100 meters, the detector tuning coil L1 and the oscillator coil L2 were each wound with 103 turns of No. 26 double-silk-covered enameled wire on a bakelite tube 1 5/8 in. in diameter and 2 5/8 in. long, tapped at 3, 8, 18, 60, and 103 turns, as shown in A and B, Fig. 3.

The tickler coil for the oscillator was wound with 30 turns of No. 26 D.S.C. enameled wire as shown in the figure.

Coupling between the oscillator and detector tuning coils was accomplished by merely spacing them 5 inches on centers as shown in Fig. 3. Both the oscillator and the detector tuning tap switches are gauged together, the type used being given in the parts list below.

In order to secure good spacing of the stations over the condenser dials it was found imperative to use S.L.F. (straight line frequency) condensers.

List of Parts

- 3 Mershon copper-case electrolytic condensers, 8 mf. each, C21, C22, C23;

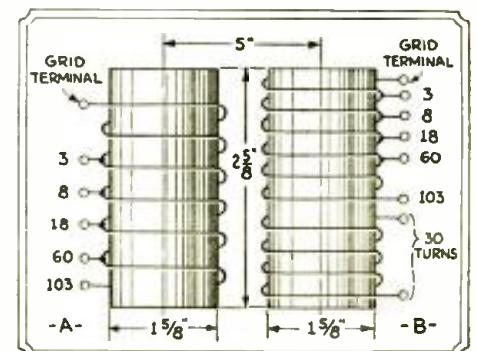

Fig. 3
Coils L1 and L2, wound in the same direction, are separated 5 in.

- 1 2-meg. grid leak;
- 1 .00025-mf. grid condenser, C24;
- 1 Push-pull input audio transformer, T1;
- 9 UY sockets;
- 1 UX socket;
- 1 .002-mf. Dubilier condenser, C20;
- 1 200 ohm Ward Leonard resistor, R13.

RADIO CRAFT KINKS

CONNECTIONS FOR 110 V., D.C.

By Oscar Block

IN those districts where the "Ham" is accursed with D.C. mains and at the same time uses '01A tubes (or other .25-amp. types) either one of two methods of connecting the filaments may be used, as shown in A and B, Fig. 1.

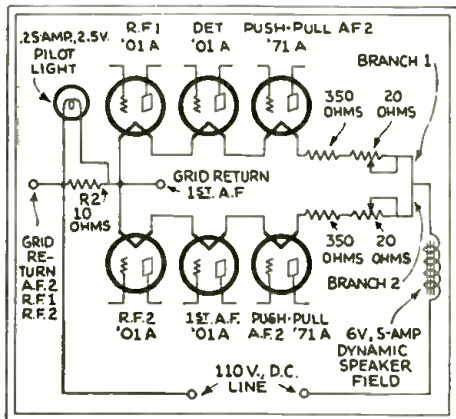

Fig. 2

Final connection of the series-parallel circuit C, Fig. 1. Resistors R1, 350 ohms; R3, 20 ohms.

Circuit A has the advantage of low current consumption, but has the disadvantage that the "B" battery potential on each tube will be low. It is also not adaptable to push-pull circuits since this type of hookup requires a parallel connection of the filaments in order to use conventional push-pull transformers.

Circuit B illustrates a series-parallel connection of filaments. This mode of connection has none of the disadvantages inherent in the connections of Fig. 1A, although the current drain is greater. It has the distinct disadvantage that if one of the tubes are removed, the increase of current through the tube with which it is in parallel is apt to burn it out. Figure 1C shows a circuit that eliminates this latter difficulty and at the same time retains all of the advantages offered by the connections of Fig. 1B.

In this case, since each branch of the filament circuit and its regulating resistance is independent of the other branch, any fluctuation in one will not manifest itself in the other. A suggested layout for the

power unit of a D.C. set is depicted in Fig. 2. This layout is designed for .25-amp. tubes and is intended for those of '71A type. The pilot light should consume .25-ampere at 2.5 V.

If tubes are used with characteristics other than those assumed, then the values of R1, R3, and the grid returns of the various tubes, must be changed. The variable 20 ohm resistor R3 is placed in the circuit to compensate for line voltage irregularities. It is to be adjusted until the voltage across the tubes is at its rated value.

It would be interesting to determine just how the various values of resistances used in this connection are determined.

First, it is known that the line voltage is 110, and, second, that the terminal voltage of each tube is 5.0. The pilot lamp requires 2.5 volts for operation. Each branch of the circuit has three tubes in series, and since each tube requires 5.0 volts, the three tubes must have 15 volts. This voltage, when added to the 2.5 volts of the Pilot lamp, gives a total of 17.5 volts, which, when subtracted from the 110 volts of the supply line, leaves a remainder of 92.5 volts across both R1 and R3.

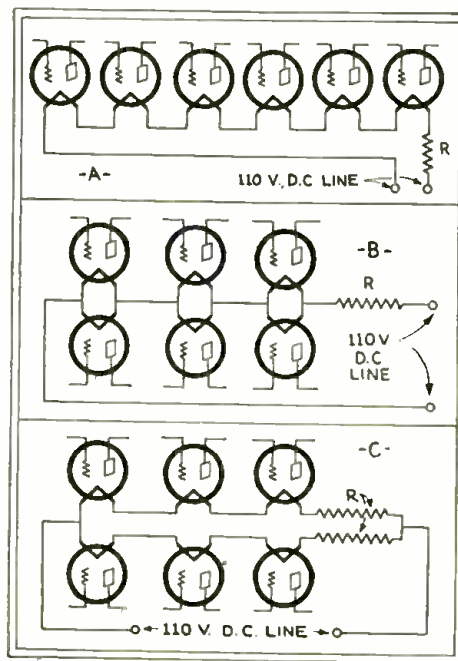

Fig. 1

"DC"-type filament connections. Circuit A consumes little filament current, but "B" potential is low; that of B, results in high "A" current and "B" potential, and; C, a safer arrangement.

Now the current through either branch 1 or 2 is the filament current of the tubes, which in this case is .25-ampere. The resistance of both R1 and R3 is then computed from the formula $R = \frac{E}{I} = \frac{92.5}{.25} = 370$ ohms. In order to provide a means of adjusting the filament voltage, 350 of the 370 ohms are made fixed and the remaining 20 ohms variable. The computation is exactly the same for either branch.

ADDITIONAL METER SCALES

By J. Christine

THE trend in service equipment, for the man who "rolls his own," is to use one instrument for a multiplicity of purposes. If a single meter is to be used as a voltmeter, ammeter, milliammeter, ohmmeter, capacity meter, etc., the numerous scales that are necessary complicate the reading of the meter to such an extent as to make the instrument impractical. If separate scales are to be used, then we are faced with the problem of removing the glass from the meter every time a change in the scale is to be effected. The novel scheme illustrated in Fig. 3 overcomes this difficulty.

The zero and top mark lines of the meter scale are drawn on the second scale to facilitate lining it up when it is placed on the instrument. The meter is then calibrated and the markings placed on the new scale.

With this arrangement it is possible to use as many extra scales as is desired, without, at the same time, opening the actual instrument itself.

A SIMPLE METHOD FOR MEASURING A.C. RIPPLE IN FILTERS

By Clifford E. Denton

THERE are many times when the experimenter or Service Man wants to know the exact ripple voltage from a high voltage power system or motor-generator.

A simple method which has been used by the author for this purpose employs a rectifier-type A.C. voltmeter, which will measure the average (0.636) value of the A.C. or "ripple" voltage. See Fig. 4.

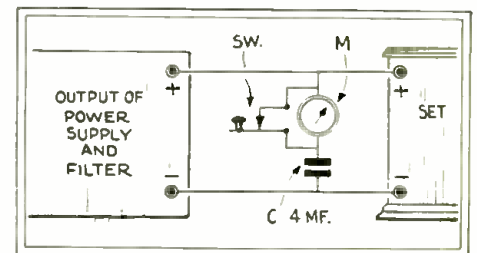

Fig. 4

Measuring "ripple." A.C. Voltmeter M, D.C.-insulated by C, indicates potential when switch Sw. is depressed.

To isolate the meter M from the D.C., but allow the A.C. to pass through it, condenser C is used; a 4-mf. high-voltage type unit will be satisfactory.

It is important that the "working" voltage of the condenser be equal to, or greater than, the power supply's "peak" voltage; which is equal to the "R.M.S." value of the voltage applied to the plate of the rectifier tube, multiplied by 1.41.

The switch Sw. should be of the closed-circuit type, which remains closed except when pressed; this to prevent the initial charging current drawn by the condenser C from passing through the meter. The meter should be connected into the circuit only after the receiver is in operation. This places the actual working load on the filter

(Continued on page 302)

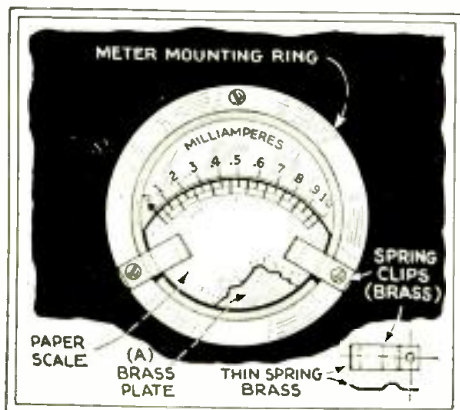

Fig. 3

The desired paper scale is pasted over a removable non-magnetic plate (A).

SM

10 TO 550 METERS WITHOUT PLUG-IN COILS

726SW All-Wave Superhet

In the 726SW there is available for the first time a combination of the very latest and most modern superheterodyne broadcast and short-wave designs on one chassis. Logically, it is the product of McMurdo Silver and the Silver-Marshall laboratories—foremost superheterodyne designers in America.

Nine-Tube Vario-Mu Broadcast Super

In the 200 to 550 meter band, the 726SW is a nine-tube vario-mu pentode superhet employing nine tuned circuits. One precedes the '51 r.f. stage, a second is before the '24 first detector, and another with the '27 oscillator. The two tuned circuits ahead of the first detector, coupled with the '51 vario-mu tube, absolutely eliminate all cross-talk or image frequency interference. The two-stage i.f. amplifier, using '51 tubes, has a total of six tuned circuits (three siamese, or dual tuned transformers) which definitely assures uniform and absolute 10 kc. selectivity at short or long waves.

Pentode Tubes in Push-Pull

A '27 second linear power detector feeds a compensated push-pull '47 pentode audio stage delivering from 5 to 7 watts undistorted power output, and in turn feeds a specially compensated electro-dynamic speaker unit.

60 to 100 Broadcast Programs

The broadcast sensitivity ranges from less than one-half to seven-tenths of one microvolt per meter—so great that every station above the noise level can be tuned in easily. The selectivity is absolute 10 kc., and in any large city distant stations on channels adjacent to locals can be readily tuned in. From 60 to 100 different stations can be logged almost any night in any fair location.

Eleven-Tube Short-Wave Super

The short-wave end of the 726SW is the dream of old—a true eleven-tube superhet using "double-suping" on not one, but

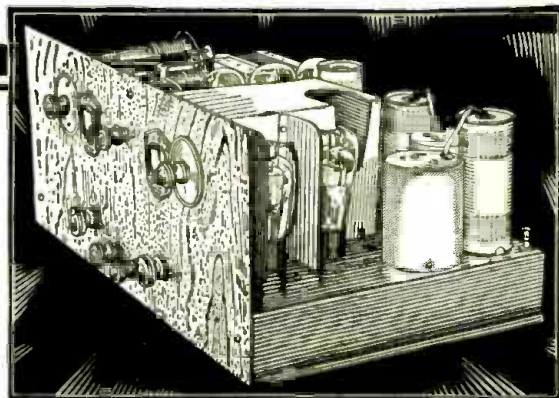

two, intermediate frequencies. Yet it has but one dial—plus a non-critical trimmer! For short-waves, a '24 first detector and '27 oscillator ganged' together are added by a turn of a switch, which selects between short-wave and broadcast band reception. A second selector switch chooses between four ranges (from 10 to 200 meters) at will—and all without a single plug-in coil.

Thousands of Miles of S-W Range

The sensitivity, selectivity on short-waves are exactly equal to the broadcast band—giving thousands of miles of range.

Tubes required: 2-'24's, 3-'27's, 3-'51's, 2-'47's, 1-'80.

726SW All-Wave Superheterodyne, complete as described above, wired, tested, licensed, including S-M 855 electro-dynamic speaker unit. Size 20½" long, 12" deep, 8½" high. To be used on 110-120 volt, 50-60 cycle AC power. Price \$139.50 LIST.

Write for *New General Parts Catalog*

The new Catalog gives detailed data on a complete new line of chassis, kits, amplifiers, replacement parts, etc. Everything from a short-wave converter without plug-in coils, to a new line of transformers.

SILVER-MARSHALL, Inc.
6419 West 65th Street • Chicago, U. S. A.

Canadian Division: SILVER-MARSHALL of CANADA, Ltd.
75 Sherbourne Street, Toronto

SILVER-MARSHALL, Inc.

6419 W. 65th Street, Chicago, U. S. A.

Please send me full details on the S-M 726 SW (enclosed you will find 2c).

Please send me FREE your new General Parts Catalog.

Name

Address

The Radio Craftsman's Page

The Bulletin Board for Our Experimental Readers

THE STENODE RADIOSTAT

IN engineering circles, interest in the "Stenode Radiostat" has been at top pitch since the first public announcement that there was in the process of refinement a system of reception which made available a receiver of hitherto unheard of selectivity, combined with exceptionally good tone-quality and a very high signal-to-static ratio.

What is believed to have been the first really extensive analysis of all literature then available on this subject, and its presentation in more readily understandable terms, was the article, "The 'Stenode Radiostat' System," by Clyde J. Fitch, which appeared on page 210 of the October, 1930 issue of RADIO-CRAFT.

It was this article which prompted Mr. Arthur Lynch, then vice-president of the Stenode Corporation of America, to prevail upon Dr. Robinson to prepare for the readers of RADIO-CRAFT a memorandum concerning certain phases of the original story.

This memorandum, dated July 16, 1931, and written in the light of later knowledge, we take pleasure in presenting below. It is preceded by the letter of Mr. Lynch; and is followed by the interesting remarks of Mr. Fitch.—*Editor.*

EUROPEAN DATA ERRONEOUS

Editor, RADIO-CRAFT:

Some time ago an article by Clyde J. Fitch appeared in RADIO-CRAFT, which was intended to be an outline of the fundamental principles on which the Stenode works.

While the article was extremely interesting, there are a number of points about it which are not entirely correct, and I feel sure that some of Mr. Fitch's deductions were the result of published reports on the Stenode made by some of the European investigators who were not sufficiently familiar with Dr. Robinson's work to have all the facts, and who, therefore, drew some erroneous conclusions.

Before Dr. Robinson returned to London last month, I asked him to analyze Mr. Fitch's article and prepare a memorandum for me dealing with the subject. I am inclosing a copy of this memorandum and, since the Stenode is bound to become a matter of increasing importance with your readers, it seems to me that the re-publication of Mr. Fitch's article along with Dr. Robinson's discussion of it would be helpful.

Cordially yours,

ARTHUR H. LYNCH, *Vice-President,*
The Stenode Corp. of America,
Hempstead Gardens,
Long Island, N. Y.

(A recent Stenode release states that the Hempstead laboratories of the company have suspended operations, only its executive offices being retained to take care of the details which concern manufacturing licenses, certain development work for government service, and negotiations concerning use of the system in telegraphic and

cable systems. Laboratory work will be continued, however, at the home office in England.—*Tech. Ed.*)

ANNOUNCEMENT

WITH this issue of RADIO-CRAFT, Mr. Louis Martin, formerly an instructor of RCA Institutes, Inc., assumes the position of Associate Editor, succeeding Mr. C. P. Mason, who, after exhibiting exceptional ability, and diversity of knowledge, has been invited to take the position of Associate Editor of Mr. Hugo Gernsback's newest publication, EVERYDAY SCIENCE AND MECHANICS.

Mr. Martin brings to RADIO-CRAFT a wealth of laboratory, theoretical, and practical knowledge; and, through his position as instructor, an appreciation of the troubles and viewpoints of technicians at every stage of advancement, which will be of inestimable value. It will be part of the duties of Mr. Martin to pass upon all the technical queries that are received; and thus it is that every reader will have an opportunity to benefit.

DOCTOR ROBINSON REPLIES

Editor, RADIO-CRAFT:

Mr. Fitch undoubtedly devoted a considerable amount of thought to the new problems in radio which were introduced by the Stenode. The first thing which struck him was that the sideband theory made it absolutely impossible to receive modulated waves on a highly selective receiver such as that provided by the Piezo-electric effect of a quartz crystal.

He does not deny that we receive modulations by such a device, and in fact he gives us the credit for being honest and reporting correctly what we had observed. He thinks that our reasoning was incorrect insofar as the sideband theory appeared to him to prevent our receiving modulations from pure amplitude-modulated waves. He draws the conclusion that every station that we receive must be doubly modulated, i. e., both amplitude- and frequency-modulated. In fact, he concludes quite definitely that it is the frequency modulation effects which account for the reception of the modulations on such a highly selective receiver as the Stenode.

Mr. Fitch must know that a strict watch is kept on all transmitting stations. In any case, this is the condition in Europe. (The new Frequency Monitoring Station at Grand Island, Nebraska, was built solely for this service; although the large number of stations in America necessarily increases the difficulties many fold.—*Tech. Ed.*) Records of the European stations are kept to show the carrier frequency varies over long periods of time, and it is interesting to know that some of the bigger stations in Europe do not deviate from their carrier frequency

by more than *one or two cycles*. This does not show that carrier frequency does not vary at a high speed—*within audio range*, in the course of a few hours! Other records are also kept, these being the amount of frequency-modulation which occurs at the various stations, and again it is interesting to note that in some of the best stations the frequency modulation, even for the loudest signals, is well under *one cycle* (quite sufficient to operate Stenode receivers).

On the other hand, there are some stations whose frequency varies considerably from hour to hour, and farther than this, which have very pronounced frequency-modulation. One such station in Europe is Toulouse, and Mr. Fitch will be interested to know that with this station, very poor results are obtained with the Stenode as regards quality. This fact has been witnessed by some of the best known radio engineers of today, and has had a profound influence wherever engineers may have had the opinion that frequency-modulation contributed to the results.

Perhaps Mr. Fitch has now had an opportunity of studying the theory of the Stenode which I gave in my last paper before the Radio Club of America last November. It was made very obvious there that we can receive modulations from pure amplitude-modulated transmitters, and a formula was given which is now called the "Stenode Formula," to show precisely how modulated waves are received by very highly selective receivers. This formula shows that a very selective receiver cuts down the "percentage modulation" of incoming waves, and the various factors which control this are included in the formula.

It will be noted from the preceding that I am aware of other scientists than Mr. Fitch, who in the middle of 1930 had the same opinions as are expressed in this RADIO-CRAFT article. Mr. Fitch was, therefore, not alone in his reasoning, but in fact shared these opinions with some other scientists. I feel sure that when he has studied my paper, which was referred to above, and when he has had experience with actual Stenode receivers, he will be convinced that the effects of the Stenode are obtained quite independently of any frequency modulation.

There is one other feature of the article which is illuminating, and this is that my original publication of the results of the Stenode led certain engineers to conclude that sidebands did not exist. Mr. Fitch avoids any definite statements attributing these views to myself. I have never said there are no sidebands, but I have always looked on the sideband theory in what I consider to be its correct form, which is that any modulated wave can be treated mathematically so that the same result will be obtained if we had a number of continuous waves of correct frequency amplitude and phase. Starting out from this point, I showed that the results of the Stenode can be explained by completing the sideband

(Continued on page 314)

HERE'S Your Buy in Auto Radios!

\$69⁰⁰

Installed, Complete

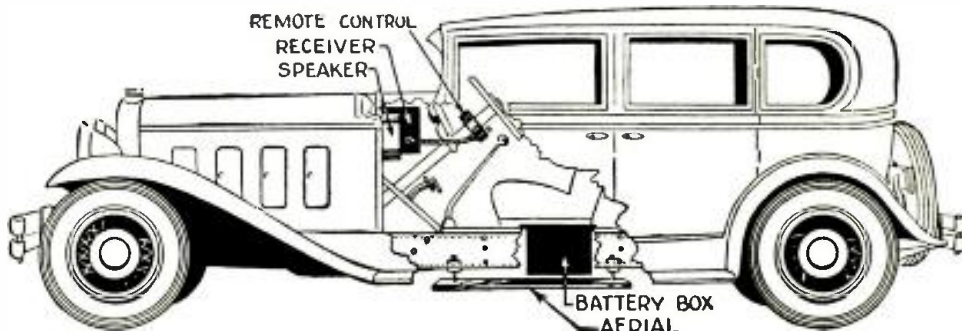

Remote Control

Remote Tuning Control clamps on steering column as illustrated above. Provides positive control without back-lash. A volume control and lock type "off and on" switch, complete the assembly.



Dynamic Speaker

A special speaker is provided of a type designed to reproduce faithfully when installed in the car. Mounts to dash board. Stunning finish—actually adds to appearance of car.

Advance Auto Radio Newest, Superpower 6 Tube Screen-Grid Set

DON'T pay more than \$69.00 for an Auto Radio installed complete—you will be throwing money away!

At that low price you can get the newest, finest Screen-Grid Receiver on the market, guaranteed to be equal to electric set in distance, volume and tone quality. The ADVANCE Auto Radio is compact—out of sight—completely shielded. Has positive Remote Control without backlash. Rugged fool-proof construction. Perfect reception at ANY speed—and the most wonderful full, rich tone you have ever heard!

Absolutely nothing to buy! Price includes receiver complete with tubes (4 Screen-Grid, a 227 and a 112 tube), powerful dynamic loud-speaker, 2 B batteries, C battery, Battery Box, car

frame aerial, aerial plate, Ignition Kit for noise elimination, etc.

Satisfaction Guaranteed

Each and every ADVANCE Auto Radio Receiver has been tested at the factory—both mechanically and electrically—by experienced radio engineers. Set is built and backed by radio manufacturer of twelve years' experience, nationally known. Your satisfaction is guaranteed. Set should outlast your car. Quickly and simply installed—does not deface the car.

Do not buy any Auto Radio at any price until you hear the ADVANCE. Write us for full facts and name of your nearest ADVANCE dealer. Mail coupon today—as special price offer has time limit. Do it, NOW!

DEALERS! SERVICE MEN!

Write at once for details about special proposition and liberal discounts. A real opportunity for live wires in the fastest growing branch of radio business. Write.

ADVANCE RADIO CORPORATION

2007 So. Michigan Blvd. Dept. 831-P Chicago, Ill.

MAIL THE COUPON

ADVANCE RADIO CORPORATION Dept. 831-P
2007 So. Michigan Blvd.
Chicago, Ill.
Please send me, without obligation, full facts about ADVANCE AUTO RADIO at special low price of \$69.00. Also give name of my nearest dealer.

NAME

ADDRESS

CITY..... STATE.....

I am interested in your Special Proposition to Dealers and Service men.

Radio-Craft's Information Bureau

SPECIAL NOTICE TO CORRESPONDENTS: Ask as many questions as you like, but please observe these rules:

Furnish sufficient information, and draw a careful diagram when needed, to explain your meaning; use only one side of the paper. List each question.

Those questions which are found to represent the greatest general interest will be published here, to the extent that space permits. At least five weeks must elapse between the receipt of a question and the appearance of its answer here.

Replies, magazines, etc., cannot be sent C. O. D.

Inquiries can be answered by mail only when accompanied by 25 cents (stamps) for each separate question.

Other inquiries should be marked "For Publication," to avoid misunderstanding.

PENTODE PORTABLE

(136) Mr. R. W. Miller, Edina, Mo.

(Q.) I have built the "Pentode Portable" described in the August issue of RADIO-CRAFT. It sure is a knockout. When using a good aerial, at night I can bring in stations up to about a thousand miles, with plenty of volume for loud speaker!

I have some trouble making the set regenerate. Sometimes it works fine; and the next time it will not work at all. I have tried different tubes, but it doesn't seem to help. Can you give me any suggestions to make it regenerate?

(A.) As reference to the circuit of this interesting two-tube receiver will indicate, regeneration is controlled by the motion of a rotor inductance or variable tickler, L2; just as in the earlier and familiar "Ambassador" sets. Consequently, the considerations for obtaining regeneration and oscillation are almost identical.

It would appear that there is a loose connection in the receiver; since Mr. Miller reports that at times regeneration control is perfect (stations a thousand miles away being received with good loud-speaker volume). It will be well, also, to check the condition of the aerial; a corroded joint, or rubbing contact to ground, might cause the effect. Try another grid leak. Check the condition of the batteries. The tuning condenser may be defective; it may short- or open-circuit in some positions of the rotor. If the receiver lacks sufficient regeneration at one end of the tuning band, the number of turns in L2 should be increased or decreased, until the regeneration control passes inspection. Make sure all battery connections and leads are perfect. If the tubes are good, and making solid electrical contact, a thorough check-up along the lines suggested should isolate the fault.

MULTI-RANGE OSCILLATOR

(137) Mr. Guy H. Allen, South Bend, Ind.

(Q.) I have an inductor of 85 turns of No. 26 C.S.C. wire, which is tapped at the 40th turn. I use this in an A.C. oscillator, for balancing purposes, in a unit which covers the broadcast band from 550 to 1500 kc. I now find I am able to use this contraption on the 20-, 40-, and 80-meter amateur bands without the change of coils; thus giving me a range from at least 17,300 kc. (W2XK), 17.34 meters, to 500 kc. (WBIO), 535.4 meters.

Would you kindly explain this phenomenon; and could its calibration be relied upon if such is obtained?

(A.) Our inquirer has discovered the phenomenon of harmonic frequency production, so often discussed in RADIO-CRAFT. The statement may be recalled that, in an oscillatory circuit including an ordinary vacuum tube, there is produced not only the fundamental frequency of that circuit (due to the values of its inductance and capacity—see Table I, page 55, July 1931 issue), but also numerous other frequencies which are multiples of the fundamental. These "harmonic" frequencies are rated in their numerical sequence: the first multiple being the "second harmonic" or double the fundamental frequency; the second multiple is the third harmonic, or three times the fundamental; and so on.

We fear our correspondent did not read this July 1931 RADIO-CRAFT; wherein, on page 10, is described an "All-Wave Oscillator for Modern Servicing" which commercializes the phenomenon of harmonic-frequency production.

The practicability of calibration, obviously, is evident at least, for the 200- to 1500-kc. band specified. Further, this method is used in amateur radio transmitting work to calibrate accurately short-

wave wavemeters; the signals of crystal-controlled stations are used for the fundamental; to which may be tuned (by zero-beat) a vacuum-tube oscillator, whose harmonics may be logged on graph paper for further reference.

Constancy and accuracy of calibration are largely a matter of obtaining constant current supply and uniform tube characteristics. In general, quite close work may be done.

AMPLIFIER GAIN

Edward G. Kertz & Associates, Kenosha, Wis.

(Q.) We would like to know how much gain it takes to make a good recording, and we would also like to know the impedance of pickups suitable for recordings.

(A.) For recording on aluminum, the level at the cutting head should be about +20 decibels. If a carbon microphone is used, the pickup volume level is down about -36 db. It is obvious, therefore, that an amplifier having a gain of at least 56 db. is necessary.

If celluloid is to be used, the required recording level is near +36 db. and, consequently, an amplifier having a gain of at least 72 db. is necessary. A good three-stage transformer-coupled job will serve the purpose very nicely.

The impedance of the cutting head does not make any difference, so long as it is properly matched to the output of the amplifier. The use of a high-impedance cutter of the order of 4000 ohms is common practice.

RECORDING VOLUME

Mr. C. L. Wentworth, Minneapolis, Minn.

(Q.) We are using a special celluloid for recording and find it difficult to get the grooves deep enough to give us sufficient volume. We have seen "electrical transcription" records, from some California recording studios, that seem to be made on this same material; and we wonder how it is possible to overcome this lack of volume.

(A.) Your lack of volume is not due to the shallow groove. A shallow groove might make it difficult for the reproducing needle to track, but the lack of volume is due to the modulations being too small. This can be caused by several things: either the amplifier's gain is not high enough; there is improper impedance matching between cutting head and amplifier; or the material might be too resistant for good recording. The transcription records are processed records—that is, a metal stamper is used to impress the sound track. In that case the hardness of the material is reduced considerably, by heating, so that it will take an impression. Try using celluloid that contains no pigment (coloring).

PICKUP CONNECTION

Mr. Thomas M. Graves, Oskaloosa, Iowa.

(Q.) I have an Apex "Model B-31" radio receiver and a good Patent pickup. I would like to know where to tap in on the loud speaker to make records.

(A.) Your cutting head's leads should be connected to the plates of the output tubes. The simplest way is to use adapters which make contact to the plate prongs, in the manner illustrated in the September, 1931 issue of RADIO-CRAFT.

FREQUENCY RANGE

Mr. Hans Behrsin, South Braintree, Mass.

(Q.) Will you tell me if a frequency range of 15 to 6000 cycles will record the highest and lowest frequencies?

(A.) A frequency range of 35-6000 cycles is very suitable for good recording. As a matter of fact, the maximum reproduced frequency in talking pictures is never more than 6000 cycles; while broadcasters limit themselves to about 5000 cycles.

COMMERCIAL RECORDS

Mr. R. J. Dwyer, Rochester, N. Y.

(Q.) In commercial recording, the wax "master" is electro-plated. Test records are stamped from this; then a metal "mother" is made from this original negative (by electroplating once again); and from the metal mother is made the production negative "stamper" (or stampers) from which the composition records for commercial use are finally made. Inasmuch as, in instantaneous recording with aluminum discs, we have the equivalent of the metal mother (the first step, or the original, and the first negative from this, being eliminated) cannot a metal negative be obtained from this, by electroplating; whereby the home recordist might have records stamped on regular record composition or celluloid and thus be able to obtain additional records from the original which, duplicated, might be played in the ordinary way on the regular phonograph using the regulation steel needles?

(A.) You are right in assuming that the aluminum disc is the equivalent of the metal mother. Stampers have been made from these aluminum discs by the plating process, and the results have been fairly good. The only objection is that the groove in the stamped record is as shallow as the aluminum record; and that is not as deep as the groove on the commercial record.

A better method of making copies of the original would be to "dub" (re-record) the original on a wax disc, and then obtain the stampers in the conventional manner.

PRE-GROOVED RECORDS

Mr. A. B. Anderson, Gulfport, Miss.

(Q.) If aluminum records were pre-grooved, would this lessen the resistance to the recording stylus and give better recording?

(A.) Pre-grooving aluminum records will not materially lessen the resistance to the recording stylus or give better recording. The only purpose in pre-grooving records is to do away with the feed-screw, and thus simplify the recording apparatus. Aluminum pre-grooved records are now on the market, and very good results are obtained with them.

COMPUTATION OF DECIBELS

The decibel, so often used in the work of audio amplification, transmission and reproduction, is simply the ratio between the strengths of any two signals, or the ratio of change in the energy of a signal when it is amplified or attenuated.

Ten decibels "up" on a signal means that the power has been increased tenfold; ten decibels down, that it has been divided by ten. The steps are unequal, but the peculiarities of this method of rating are based on physiological and engineering reasons. The decibel, as a mathematician would instantly see from the table given here, is a logarithmic unit (the number of decibels is represented by ten times the "common" logarithm of the ratio of change.)

Since the sound energy of the reproducer should be, approximately, in proportion to the electrical output power; and since electric power is measured by "voltage times current," the power varies as the square of the voltage (or current). Therefore, the ratio of energy change corresponding to ten

decibels is as much as the ratio of voltage (or current) change, corresponding to twenty decibels. Any signal strength may be taken as the base (or zero) in computing relative intensities. However, for voice-transmission measurements, six milli-watts (1.73 volts across a 500-ohm line) is a standard used by engineers. The ratio of change in power, and in voltage (or current) corresponding to any number of decibels, may be quickly found from the following table. Multiply the signal strength, or voltage, which is taken as the base, by the factor given in the proper column, opposite the appropriate number of decibels.

"UP"			"DOWN"		
Energy	Voltage	DECIBELS Number	Energy	Voltage	
1.26	1.12	1	0.796	0.891	
1.69	1.26	2	.631	.796	
2.00	1.41	3	.501	.708	
2.61	1.59	4	.388	.631	
3.16	1.79	5	.316	.562	
3.98	2.00	6	.251	0.501	
5.01	2.24	7	.199	.447	
6.31	2.51	8	.158	.398	
7.94	2.82	9	.126	.355	
10.00	3.16	10	.100	.316	
12.59	3.55	11	.079	0.282	
15.85	3.98	12	.063	.261	
19.96	4.47	13	.050	.224	
25.12	5.01	14	.040	.200	
31.62	5.62	15	.032	.178	
39.81	6.31	16	.025	0.158	
50.12	7.08	17	.020	.141	
63.10	7.94	18	.016	.126	
79.43	8.91	19	.013	.112	
100.00	10.00	20	.010	.100	
125.9	11.22	22	.0079	.089	
158.5	12.59	22	.0063	.079	
199.6	14.13	23	.0050	.071	
251.2	15.85	24	.0040	.063	
316.2	17.78	25	.0032	.056	
398.1	19.96	26	.0023	.050	
501.2	22.39	27	.0020	.047	
631.0	25.12	28	.0016	.040	
794.3	28.16	29	.0013	.035	
1,000.0	31.62	30	.0010	.032	
1,259	35.48	31	.0008	.028	
1,585	39.81	32	.0006	.026	
1,999	44.67	33	.0005	.022	
2,512	50.12	34	.0004	.020	
3,162	56.23	35	.00032	.018	
3,981	63.10	36	.00025	.016	
5,012	70.80	37	.00020	.014	
6,310	79.43	38	.00016	.013	
7,943	89.13	39	.00013	.011	
10,000	100.00	40	.00010	.010	
12,590	112.2	41	.00008	.0089	
15,850	125.9	42	.00006	.0079	
19,960	141.3	43	.00005	.0071	
25,120	158.5	44	.00004	.0063	
31,620	177.8	45	.000032	.0056	
39,810	199.6	46	.000025	.0050	
50,120	223.9	47	.000020	.0045	
63,100	251.2	48	.000016	.0040	
79,430	282.0	49	.000013	.0035	
100,000	316.0	50	.000010	.0032	
1,000,000	1,000	80	.000001	.001	
10,000,000	3,162	70	.0000001	.0008	
100,000,000	10,000	60	.00000001	.00001	
1,000,000,000	31,620	90	.000000001	.000008	
10,000,000,000	100,000	100	.0000000001	.0000001	

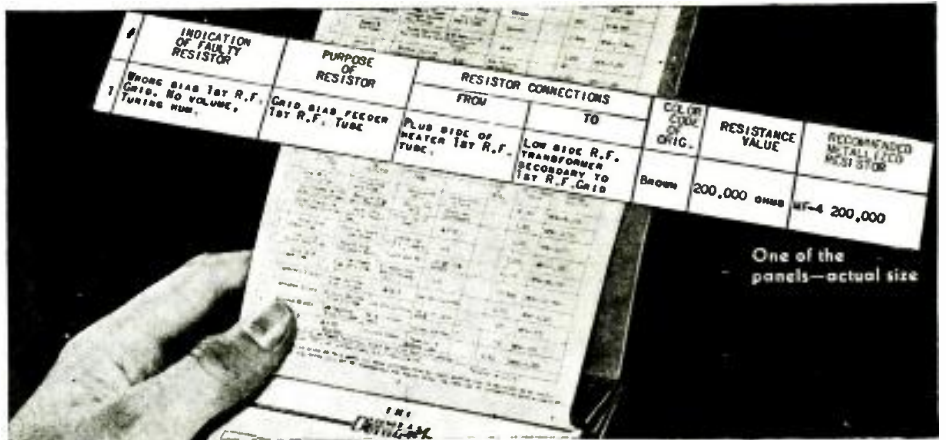

In 1/2 minute! you know what RESISTOR you need

Wouldn't you like to have the resistor question answered, *instantly*, no matter what set you're servicing? The I.R.C. Resistor Guide will do just that for you.

Once you know it is resistor trouble, this book will give the value and code, and position in the circuit of each defective unit. It lists all popular makes of receivers (over 200 circuits)—with the types to use in each.

No need to guess or worry over the proper units or values. The I.R.C. Guide will be right there in your pocket ready to do its stuff—a short cut to trouble finding. Servicemen the country over use it daily.

With the purchase of 10 Resistors, you receive our complete, authoritative Guide *free*—or it may be bought for \$1.00. Loose-leaf sheets, made up by our engineers, are mailed periodically, without charge, to every Guide owner—keep it constantly up to date. Thousands of sets this fall will need servicing. Be ready to get your share of the business. Mail the coupon today. With the Guide, we send new I.R.C. Color Code Chart, quickly telling range and type of any resistor.

Published by
INTERNATIONAL RESISTANCE CO.

Philadelphia -- -- Toronto

Ask your jobber for

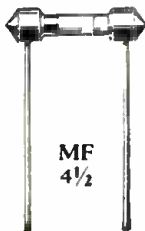

Metallized

Also Precision Wire Wound

RESISTORS

INTERNATIONAL RESISTANCE CO. C-11
2006 Chestnut St., Philadelphia

Gentlemen: (Check offer you are interested in)
 I enclose \$1.00 for Replacement Guide.
 Send prices. Metallized Resistors. I wish to buy assortment of 10, entitling me to Resistor Guide Free.

NAME

ADDRESS

CITY..... STATE.....



Readrite

No. 550

OSCILLATOR

(Licensed by A. T. & T. Co.)

\$18 Net to dealer \$30 list **\$21** Net to dealer with output meter

If not at your Jobbers, we will ship direct when remittance accompanies order.

A sturdy modulated instrument carefully made. Completely shielded with separate battery compartment. Furnished with 22½-v. and 3-v. batteries. Uses one '30 tube. Covers broadcast band (550-1500-k.c.) and intermediate band (120-185 k.c.). Operating instructions attached in case cover with shielded wire leads. Very compact. In leatherette case, 6 x 11½ x 5½ in. Weighs but 8 pounds. Built to high standards.

Every serviceman should have the No. 550 oscillator to align r.f. gang condensers, locate defective r.f. transformers, adjust i.f. transformers, check oscillator stage and determine sensitivity of a receiver. A necessary instrument. Get yours today. Write for catalog of servicing instruments.

Readrite Meter Works
Established 1904
17 College Ave., Bluffton, Ohio

A DISTORTIONLESS DETECTOR CIRCUIT

By C. H. W. Nason

OVERLOADED detector tubes are responsible for the major proportion of the distortion acquired by the broadcast signal, in its path from microphone to speaker. Recent attempts by the writer, to receive test signals at a point directly under the station antenna, resulted in the development of a detector based on the involved principle of the balanced-modulator circuits employed in multiplex telephone work.

The balanced modulator, Fig. 1, is operated in this case with the grid circuits of two tubes in push-pull, but with the plate circuits in parallel; under normal conditions the distortion in such a circuit is so slight as to be negligible. The tubes can be

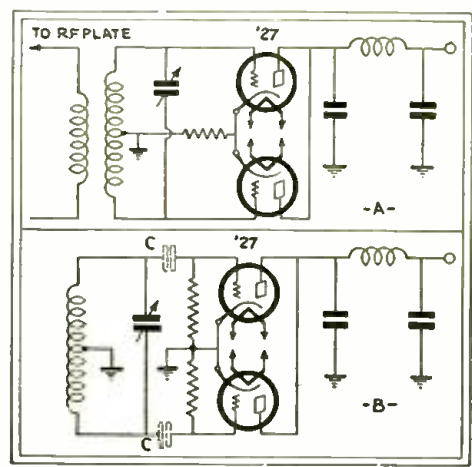

Fig. 1

Power detectors. At A, "bias"; B, "grid."

arranged either as "bias" or as "grid-circuit" detectors; in the latter case, the grid condensers are theoretically not needed, and the circuit arrangement has been shown without them. In the case of grid circuit detection (as shown for '27 type tubes) the plate current will be quite high. Negative biases for '27 tubes, when employed as plate-circuit detectors, should be as follows:

Plate Voltage	Grid-Bias
45	- 5 Volts
90	-10 "
135	-15 "
180	-20 "

With the grid-leak detector the two resistors shown should be 100,000 ohms each. After the point at which the plates of the two tubes are joined together, circuit arrangements for the balanced detector do not differ materially from those employed with ordinary detectors. The current drawn by the grid-leak type of detector, which is operated at zero grid volts, is rather high; but should offer no abnormal problems in the design of electric receivers to employ it.



SKINDERVIKEN



The Most Sensitive Microphone Button
(ACTUAL SIZE NOT BIGGER THAN A QUARTER)

You can easily make a highly sensitive detectophone by using a Skinderviken Transmitter Button to collect the sound waves. You can build your own outfit without buying expensive equipment. Think of the fun you can have with such an instrument.

You can install an outfit in your home and hear the conversation being held all over the house.

Full directions for connecting the button for use as a detectophone are given in our 12-page booklet.

These wonderful little SKINDERVIKEN microphone buttons may be used for hundreds of uses, such as:

- RADIO AMPLIFIER
- DETECTOPHONE
- STETHOSCOPE
- MICROPHONE
- PHONOGRAPH AMPLIFIER
- TELEPHONE AMPLIFIER
- LOUD SPEAKER AMPLIFIER
- CRYSTAL SET AMPLIFIER
- HOME RECORDING OUTFIT, ETC.

95c EACH Two for **\$1.75**
12-PAGE INSTRUCTION BOOKLET
containing suggestions and diagrams for innumerable uses, furnished with each unit.

EVERY AMATEUR SHOULD HAVE TWO OR THREE OF THESE AMPLIFIERS IN HIS LABORATORY

WE PAY \$5.00 IN CASH
for every new use developed for this unit and accepted and published by us.

SEND NO MONEY

When the postman delivers your order you pay him for whatever you have ordered, plus a few cents postage.

(Canada and Foreign: cash with orders)

PRESS GUILD, Inc., R-1111
16 Murray St., New York, N. Y.

Please mail me at once as many of the following items as I have indicated.

.....Skinderviken Transmitter Units at 95c. for 1; \$1.75 for 2; \$2.50 for 3; \$3.20 for 4.

When delivered I will pay the postman the cost of the items specified plus postage.

Name

Address

City..... State.....

Radio Dealers! Radio Service Men!

New Low Prices

Guaranteed Replacement Condenser Blocks and Transformers Net

Atwater-Kent 37 Cond. Block with chokes.....\$3.95

Atwater-Kent 37 Power Transformer..... 2.95

Atwater-Kent 40 Pack Complete..... 6.50

Zenith ZES, Stewart-Warner, Mohawk Blocks..... 3.45

Majestic "B" Eliminator Cond. Block..... 2.95

Electrolytic Condenser, 2 Anode..... 2.10

Electrolytic Condenser, 3 Anode..... 2.75

Hard-to-get parts—We have them

Send us your repair work for estimate

Write for our FREE CATALOGUE

Grant Radio Laboratories

6521½ South Halsted St., Chicago, Ill.

Permeability Tuning

(Continued from page 271)

or the variometer, illustrated at E, which depends for its operation upon the variation in the mutual-inductance of two rotatable coils connected in series; nor the old 3-circuit tuner, shown at F, which exhibited a *detuning* action when the natural period of the tuned circuits S-C3 was disturbed by the coupling variation of two inductances (S. T. as the rotating tickler T was varied for regeneration control).

Then we should consider still another type of tuning variation—as, for instance, the vernier change of inductance which was obtained as shown at G by the variation of the self-inductance (and distributed-capacity) of the secondary L6, as the iron *peridyne* plate P was adjusted, in one type of shielded R.F. transformer developed some time ago by Mr. H. Gernsback.

Then there is the *lowering* of inductance which results when we place over a coil, a copper, aluminum or brass (non-magnetic material) shield A1, and drop it into position A2, as shown at H; the vernier change of inductance when a “damper” plate is rotated within the center of an R.F. coil, I; and the *increase* in inductance which is obtained when an iron (magnetic material) core A1 is inserted in a coil, position A2, as illustrated at J.

Thus we arrive at the conclusion that the use of a magnetic material enables us to *increase the inductance* of a coil, enabling us to tune in stations of higher wavelength without winding on more wire (A), without tapping the coil (B), using variable condensers (C), changing the spacing of the turns of wire (D), varying the coupling of two coils in series (E), varying the coupling of two isolated coils (F), introducing a peridyne plate (G), rotating a damper plate (H), or removing a coil shield (I); the whole problem of tuning from 200 to 550 meters, using system J, resolving almost solely into the selection of the right grade of iron for the core.

Selecting the Iron

Whereas in the past, we have found ready at hand a core material, or so-called “radio frequency” iron, for inclusion in radio frequency transformer design, all previous calculations had only to deal with a primary and secondary of fixed construction; and with a response graph (to an input potential of varying frequency) taking somewhat the curve shown in Fig. 2. (Later designs show an improved response figure, as shown dotted.)

These lines indicate that the circuit is *broadly resonant*, (the design striving for the dot-dash response), and therefore there always must be associated with such units a *sharply resonant* selector circuit (a coil and condenser) for the purpose of obtaining the desired selectivity at any given point along the broadcast tuning spectrum,

as at A1, Fig. 3; the most desirable shape is that obtainable from a hand selector as at A.

It will be observed that here (solid line) cut-off is extremely sharp, and that the degree of frequency-acceptance is limited to 10 kc., as necessitated by present transmitter design; but that, as we change to a lower or higher frequency, B and C, respectively, the degree of selection becomes

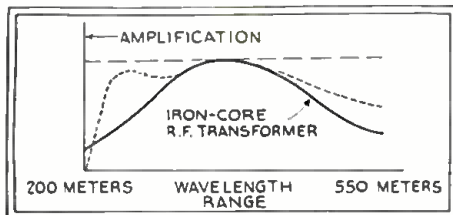

Fig. 2

Response curves of “fixed-tune” R.F. transformer. Solid line, early average; dotted, late average; dash, desired shape.

perhaps 30 kc. broad in the former instance, and 5 kc. in the latter.

From these observations it may be judged that uniform response hinges considerably on the “radio frequency” iron; and further remarks will disclose that therein lies almost the entire secret of a *self-tuning* radio frequency transformer.

Permeability

The ratio of the magnetic flux that passes through a substance, to the flux that would exist in air if the magnetomotive force (ampere turns) and flux path remained unchanged, is the definition of permeability. Therefore, *permeance* may be defined as that property of a magnetic circuit which allows the flow of magnetic flux; and the facility with which it permits this flux flow is an indication of its *permeability*.

Inductance, on the other hand, is defined as that property which has the effect of storing up energy in the form of a magnetic field. With a given number of turns (and a given shape), the inductance increases as the strength of the magnetic field increases (while maintaining the current constant).

Consequently, anything we can do to increase the strength of the field without changing the current, will increase the inductance of the coil.

Substitute iron for air, for instance, and the former being more “conductive” to a magnetic field (that is, having greater *permeance*, or less resistance) than air, the

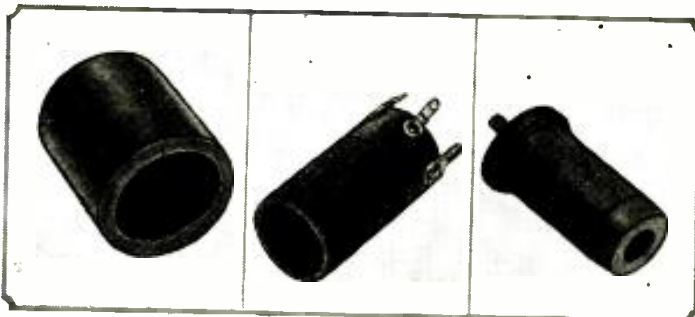

Fig. B

A disassembled permeability tuner. Left, the “R.F. iron” case; center, tuning coil; and right, “R.F. iron” plug.

CHOOSE YOUR BRANCH OF RADIO

SEEK ADVANCEMENT...adventure in aircraft radio ... broadcast station or studio ... direction finder or radio compass ... disc and film recording ... talking pictures ... servicing of home entertainment equipment ... television.



HERE is a list of 7 thrilling branches of radio ... choose the one you like...learn it and fit yourself for a place in radio's big new future!

RCA Institutes, Inc., at four resident schools—in New York, Boston, Chicago, Philadelphia—offers elementary and advanced courses, based on 22 years experience, in practical radio. Associated with largest, most complete research laboratory in the radio industry. Advanced methods, outstanding instructors.

Win Radio Scholarship

Extension Courses enable you to study at home, if preferred. Free radio scholarship at resident school offered. Now is the time to study. Training is essential to success in the radio industry. Decide today! Tear out and mail the coupon today for free book, full details. RCA Institutes, Inc., 75 Varick Street, New York City.

RCA INSTITUTES, Inc.

RCA Institutes, Inc., Dept. NP-11, 75 Varick Street, N. Y. Gentlemen: Please send me your General Catalog. I am checking below the phase of radio in which I am particularly interested.

- Aircraft Radio
- Broadcast Station or Studio
- Talking Pictures
- Direction Finder and Radio Compass
- Disc and Film Recording
- Servicing Home Entertainment Equipment
- Television

Name _____

Address _____

Occupation _____

The Voltage 'POLICEMAN' in Your RADIO



AMPERITE corrects line voltage variations. Improves reception. Installed in 5 minutes. No chassis changes. \$3 at your dealers. Write Dept. RC-11, giving make and model No. of your set. For Every Set Including Midgets.

AMPERITE Corporation
501 BROADWAY, NEW YORK

AMPERITE
Self-Adjusting
LINE VOLTAGE CONTROL

PENTODE SUPER
6-Tube Midget at Amazing Low Price!

The best tuned small receiver on the market. Uses 1-235, 1-234, 2-227's, 1-247, and 1-280. Full-range dynamic speaker. A superheterodyne with a big wallop. The latest product of our laboratory. Fully guaranteed.

Special Dealer's Price **\$25.75**

Made to sell for \$49.50 complete. Dealers net price only \$25.75 complete with quality tubes. Send \$3.00 with order, balance C.O.D. A great value—ORDER TODAY!

PIONEER RADIO LABORATORIES
857 W. HARRISON ST. CHICAGO, ILL.

DEALERS and Service Men

Makers of Speakers Since 1921 Offer You DIRECT SPEAKER SERVICE, by Expert Manufacturers.

We carry cone and voice coil assemblies for any Dynamic Speaker.

16" x 8 1/2" Sprayed Metal Chassis for 8-tube set, 95c; Airplane Speaker Dope—8 oz. can, 35c; Bakelite cased chokes, 85 millihenry, 35c; Farrand Magnetic Units, \$1.25; 12" x 12" x 1 1/2" Celotex, 45c; Lynch Ignition Noise Suppressors for Auto Radios, 35c.

LEOTONE RADIO COMPANY
63 Dey Street New York, N. Y.

DEALERS—SERVICE MEN!

Phosphor Bronze Dial Cables
Majestic—R.C.A.—Bosch
\$0.15 Each — \$1.50 10oz.

Phosphor Bronze Dial Wire
25 feet \$1.00 — 50 feet \$1.75

Pentode Adaptors
Allows the use of a Pentode Tube in a 45 Socket WITHOUT REWIRING. Improve Your Volume and Tone Threefold. Also used in Set Analyzers and Tube Testers. List Price \$2.50. Your Price \$0.95

Guaranteed Unbreakable Test Leads
With Solderless Test Lead Tips and Polarized Unbreakable Fibre Handles. \$0.50 Each

Bell Radio Sales Co.
1023 Intervale Avenue
Bronx, N. Y.

Study RADIO in CANADA

CANADA'S PIONEER COLLEGE, endorsed by leading radio manufacturers, offers DAY, EVENING, HOME STUDY and SPECIAL TRADE COURSES with free scholarships and trip to Toronto (all expenses paid). Write for booklet to Principal.

RADIO COLLEGE OF CANADA Limited
310 Yonge Street . . . Toronto

magnetic field is more readily built up to a high value, and thus the inductance is increased; and thus the "natural wavelength" of the coil becomes greater.

Polydoroff "R.F." Iron

The formula for the resonant frequency (f) of a tuned circuit ordinarily considers the permeability equal to that of air, or 1; consequently, it reads:

$$f = \frac{1}{2\pi\sqrt{LC}}$$

However, should there be substituted for air a magnetic material, for instance, the Polydoroff iron-dust molded core and case, then this factor must be allowed for, and the formula then reads:

$$f = \frac{1}{2\pi\sqrt{LC\mu}}$$

The permeability figure at the extreme right is about 8, for this new iron.

This metal, which seems to play such a vital part in the scheme of things, is worthy of an entire book concerning its characteristics; space, however, prevents more than passing comment on its structure and use.

The fact that eddy-current losses in iron laminations only 1 mil. thick still are excessively high, precludes its use at frequencies above 200 kc.; and shielding effects from the use of this grade of iron greatly reduce the inductance—sometimes to zero. Ordinary iron exhibits, too, high hysteric losses, due to the atomic structure of the iron.

Hysteric losses therefore may be greatly reduced by changing the atomic structure of the iron, a condition which is obtained by making it in the form of powder. (Two methods are available: one, condensation of iron carbonyl vapors; and the other, the reduction of iron in hydrogen.) Particles of 1 micron may thus be obtained; but this size is too fluffy to compress well, and therefore 10-micron (.0004-in.) particles are used.

Next in line for solution is the problem of eddy-current loss, which is due to the conductivity which exists between each particle of the iron (resulting in an absorption loss occasioned by the shorted-turn effect of the connecting, conductive particles). The answer is found in insulating each particle of the iron with a very thin varnish.

To make this resulting insulated-iron-powder workable, it is mixed with phenol resin and compressed under extreme pressure and heat; the result is a bakelite compound which looks and machines like gray iron; by weight it is 90% pure iron.

We now have available the means to produce a marvellous transformer which will have the even amplification shown dot-dash in Fig. 2; and contain within itself some means of tuning with 10 kc. selectivity at all points (using multiple-stage circuits) over the entire broadcast spectrum.

That these specifications are not absurd, is proven by reference to Fig. B; this is a view of a disassembled "Permeability Tuner." It comprises a "radio frequency" iron case (left), a little litz-wound coil (center), and a "radio frequency" iron plug (right). (The case is approximately 1 1/2 in. in diameter and 2 3/4 in. long; the coil consists of 52 turns of No. 10 x 38 litz., on a

form only 1 in. in diameter; the plug diameter is approximately 7/8 in. at one end and 1 1/8 in. at the other, and the length is about 1 7/8 in., to which must be added the length of a molded-in screw, which protrudes 1/2 in. The total weight is 9 oz.

In Fig. 4 the completed R.F. transformer, with shields, is shown in cross-section; either the coil and its shield, or the iron plug, case and its iron shield, may be moved in rela-

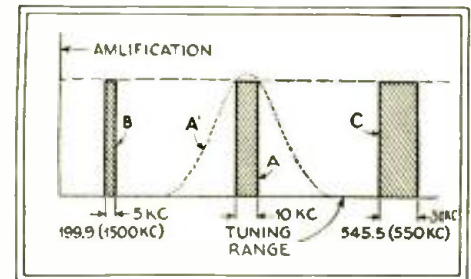

Fig. 3

The width of the response curve varies with frequency as shown at A, B and C above.

tion to the remaining (fixed) component. The device connects into a circuit in the same manner as an ordinary fixed-tune R.F. transformer.

A number of these units may be "ganged" with perfectly satisfactory results, since the characteristics of one unit are readily reproducible in another. The stage-gain of a permeability-tuned R.F. amplifier is between 50 and 60 (even better than can be obtained in ordinary capacity-tuned circuits). An experimental "permeability-tuned radio receiver is shown in Fig. C.

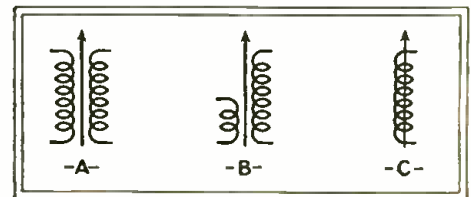

Fig. 5

Proposed symbols for permeability tuning. At A, inter-stage coil; B, antenna coil; C, a single inductance.

A symbol proposed by Radio-Craft for the "permeability tuner" is shown in Fig. 5. In addition to the single line which ordinarily is used to indicate "radio frequency" iron (and therefore, an iron-core R.F. transformer), there is added an arrowhead to indicate variability (the tuning which is accomplished by variation of the inductance of the coil).

All the possibilities of this new and astonishing instrument have not as yet been plumbed; and it remains for the ingenious experimenter to put his fertile imagination to work finding new applications of this device which, it is expected, will be available the early part of 1932.

WORLD'S RADIO MARKET

THERE are a billion people within the range of broadcast stations now established. On the basis of five listeners to every set, it would require 200,000,000 sets to provide facilities for all of them to "tune in" the programs available.—Dr. Julius Klein, Assistant Secretary of Commerce.

Novem^{ic} Microphone

(Continued from page 270)

ing R which is designed to reduce to a minimum the cavity in front of the diaphragm. The magnetic field density of 11,000 maxwells is established in the air gap, in which is placed the moving coil, by means of the permanent magnet. This is constructed of steel containing about 35% cobalt; which results in a magnet of much smaller size than ordinarily encountered in this work, and one that does not readily yield to demagnetization.

Frequency Equalization

In order to increase the low frequency response of the microphone, a tube T is inserted. The effect of this tube is to equalize the air pressure between the front and back of the microphone, and thus alter the mechanical impedance of the diaphragm so as to substantially affect the low frequency response. This equalization of pressure has also the effect of making the response independent of changes in barometric pressure.

Laboratory tests to determine the sensitivity of the microphone to background noise, revealed that the noise output is 6 DB lower than that of the Western Electric Type 394 condenser microphone. To find this value, wind velocities of from 20 to 30 miles per hour were directed against both the condenser and moving-coil type instruments, and the output measured (with the resultant figure given above).

The response of this instrument is substantially independent of temperature. Measurements, conducted at temperatures ranging from 50 degrees below zero (Fahrenheit), to 130 above, showed only a 1.5 DB variation in output.

A pre-amplifier connected to this type of instrument will require a matching transformer T, Fig. 2, with a low-impedance secondary.

Figure 3 is a response graph of the microphone as taken at different incident angles of the sound waves. Below about 900 cycles, the response is independent of the direction of the sound. Above this frequency the response varies with both the frequency and the angle of incidence of the sound, the maximum variation being only about 5 DB.

In order to determine the effect of humidity on the electrical characteristics of the microphone, a sample was placed for 5 days in a room having a constant humidity of 90%. The results indicated no deviation from normal.

A perforated metal grid G, Fig. 1, which is covered with silk, protects the diaphragm from injury. The grid and metal housing form a shield which may be grounded through one of the three jack contacts provided on the rear of the housing; the other two are connections for the external amplifier. (A cam arrangement mounted close to the jack presses the blades close to the plug, assuring positive contact at all times.)

Summary

In order that the merits of this new microphone, which, without a stand, measures 3 x 3 1/4 in. in diameter, and weighs 2 1/2 lbs.,

may be more readily grasped, they are listed as follows:

- It may be placed at a considerable distance from the pre-amplifier;
- Is adapted to use in localities indoors or out, where there exists wind or other extraneous noises;
- Simple and rugged in design;
- Frequency response graph practically uniform;
- Unaffected by atmospheric conditions;
- Conveniently located and mounted, and does not require spring mountings;
- High sensitivity, occasionally precluding the need of a pre-amplifier;
- Does not require an exciter battery;
- Is insensitive to ordinary vibration.

The Visigraph

(Continued from page 268)

(such as p, q and y) which come below the bottom of the capitals. The letters are composed of dots and of short or long dashes.

The machine is so arranged, that, without regard to the height of the letters, whether large or small, it produces them of the same size. The sheet of aluminum foil may be preserved, or passed between rollers and smoothed out, ready for use again.

This method, it may be pointed out, makes it possible to transcribe any language, or line drawings, automatically, and put them in raised form; thus extending enormously the opportunities for reading, education and usefulness open to the blind. The cost of such apparatus is dependent upon the effective demand. The principle is, of course, applicable to a greater range of purposes than that shown here; but the humanitarian character of the work shown is of unusual interest.

Latest in Radio

(Continued from page 272)

Referring again to Fig. 4, the action of the A.V.C. will cause the voltage drop across the resistance R to decrease as the signal is tuned in. The voltage between the terminals of the V.I. will then increase, the amount, depending upon the strength of the signal, which in turn depends upon how "close" the station is tuned in. The height of the discharge will be a maximum when the station is tuned to exact resonance.

This figure shows the cathode of the tune-a-lite connected to a variable arm on the bleeder resistance. This arm is for the purpose of adjusting the no-signal voltage applied to the tube until it is just equal to the ignition voltage.

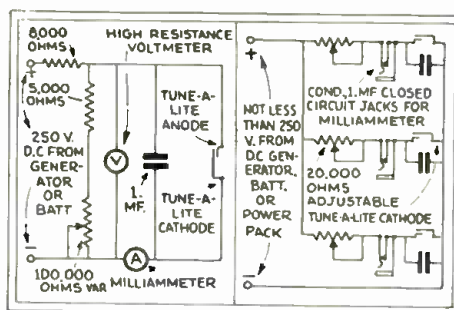
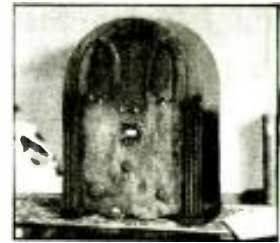

Fig. 2, left. Circuit for determining ignition and extinction voltages.

Fig. 3, right. Determining tube life.

CROSLEY

New Pentode Output Variable Mu SUPERHETERODYNE



\$36³⁶

Complete With Tubes

The Crosley

NOW your Crosley dealer **LITLFELLA** is ready to show and demonstrate the new Crosley LITLFELLA—a 5-tube table model SUPERHETERODYNE radio receiver incorporating big set features yet housed in an exquisite and convenient cabinet of choice walnut veneers 17 inches high and priced sensationally low. Pentode output, variable Mu tubes, full floating moving coil dynamic speaker, continuous (stepless) static and tone control, combined volume control and on-off switch, illuminated dial with vernier drive—such features as these make the Crosley LITLFELLA the greatest of all radio values. Only \$36.36, complete.

Push-Pull Pentode Output SUPERHETERODYNE



The Crosley **PLAYBOY**

8 TUBES **\$49⁷⁵**

Complete With the 8 Tubes

AN exquisitely designed all wood compact table model, 17 inches high, housing the new Crosley 8-tube push-pull Pentode output, variable Mu, Superheterodyne chassis with latest type Crosley full floating moving coil dynamic speaker. Incorporates all the new Crosley features. Two five-element Pentode output tubes connected in push-pull; two variable Mu tubes; continuous (stepless) variable static and tone control; illuminated hairline shadow dial with vernier drive; combined volume control and on-off switch; full floating moving coil dynamic speaker. Never before so much superlative radio performance at so low a price.

The Crosley CHEERIO

A 10" console of unusually attractive design housing the same set and speaker as in The PLAYBOY.

\$6500

Complete With the 8 Tubes

The Crosley MERRYMAKER

A truly magnificent cabinet of rare beauty, forty inches high, housing the same set as in The CHEERIO plus the Auditorium size speaker.

\$7500

Complete With the 8 Tubes

The Crosley ANNOUNCER

One of the most beautiful of all our console models. Stands forty-two inches high. Incorporates the same set and speaker as The MERRYMAKER.

\$8500

Complete With the 8 Tubes

The Crosley PLAYTIME

Here it is! A dream come true! A grandfather type A. C. electric hall clock incorporating the same set and speaker as in The ANNOUNCER.

\$9500

One connection to the A. C. house current operates clock and radio. (Western prices slightly higher.)

Complete With the 8 Tubes

Send postal for booklet Y-11

The Crosley Radio Corporation
POWEL CROSLEY, Jr., President
Home of "The Nation's Station"—WLW
CINCINNATI



YOU'RE THERE WITH A CROSLEY
CROSLEY
RADIO

Learn Chemistry

Dr. Sloane Will Teach You in Your Own Home

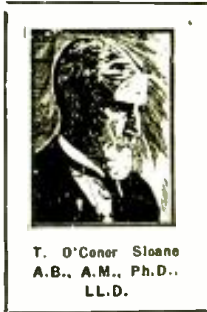

Chemistry offers those who are ambitious and willing to apply themselves conscientiously, the greatest opportunities of any vocation today. Industrial firms of all kinds pay tempting salaries to get the right men. Opportunities abound on every hand.

Now Is the Time to Study Chemistry

Never before has the world seen such splendid opportunities for chemists as exist today. In factories, mills, laboratories, radio and electrical shops, industrial plants of all kinds, chemistry plays a vital part in the continuation and expansion of the business. No profession offers such opportunities and the next ten years are going to show the greatest development in this science that this country has even seen.

You Can Learn at Home

Our home study course, written by Dr. Sloane himself, is practical, logical and remarkably simple. It is illustrated by so many experiments that are performed right from the start that anyone, no matter how little education he may have, can thoroughly understand every lesson. Dr. Sloane will, in addition, give you any individual help you may need in your studies.

Easy Monthly Payments

You do not have to have even the whole price of the course to start. You can pay in small monthly amounts, earning the cost as you go along. The tuition is very low, and includes your laboratory outfit—there are no extras to buy with our course.

Experimental Equipment Given to Every Student

We give to every student without additional charge his chemical equipment, including fifty pieces of laboratory apparatus and supplies and forty-two different chemicals and re-agents.

Tuition Price Reduced

Besides furnishing the student with his Experimental Equipment, we have been able, through the big increase in our student body, to reduce the cost of the course. Write today for full information and free book, "Opportunities for Chemists."

Mail the Coupon NOW!

CHEMICAL INSTITUTE OF NEW YORK, Inc.

HOME EXTENSION DIVISION
19 Park Place New York, N. Y.

CHEMICAL INSTITUTE OF NEW YORK,
Home Extension Division
19 Park Place, New York, N. Y.

Please send me at once, without any obligation on my part, your free book "Opportunities for Chemists," and full particulars about the Experimental Equipment given to every student. Also please tell me about your plan of payment.

NAME
ADDRESS
CITY STATE.....
RC-1131

The Antenaplex

(Continued from page 275)

At this point, a connection should be provided to the 110-V., 60 cycle supply, through a suitable fused switch; between the power supply line and the "antensifier," or group of "antensifiers," a line filter should be inserted, to insure freedom from power line noises in the Antenaplex system. The output of each "antensifier" is distributed through the building to the various "Radio (antenna and ground) Outlets," Fig. B, through the little lead covered "Cablox" cable, in diameter, (as previously described).

If the building is of the usual tall, narrow construction to be found in the large city, "risers," or vertical wire cables, should be laid out, starting at the central point in the pent house, and spreading across (under the roof) to points directly above the locations of the radio outlets. Thence these lines should be dropped down through the walls so that each line will pass through one outlet on each floor; or, if possible, two outlets placed back-to-back, or nearly so. As many as 50 outlets may be connected to each line, spaced at any convenient intervals—but in no case may branch lines be run, except where an additional "antensifier" is used to connect the branch line into the main line.

If, let us say, only 20 outlets have been employed on one of these vertical lines between roof and basement, the line may be run across the building at the lowest floor reached, and looped up into another riser, to accommodate another group of outlets, and so on at the top of the building, across and down again, until the maximum number

Figure 5 indicates another method of connecting the V.I. This method has the advantage of allowing better regulating action by the tune-a-lite. The diagram of Fig. 6 depicts still another method of connection which is especially suitable for small A.V.C. sets using the hum-bucking type of dynamic speaker, and resistance filtering.

Commercial Adaptation

Certain receivers have recently appeared on the market using a "diode" or two-element type of detector; an example of one is the Fada model "48". The tune-a-lite method of indicating resonance is used, but under the name "Flashograph." This receiver is illustrated and discussed in the first item on page 273.

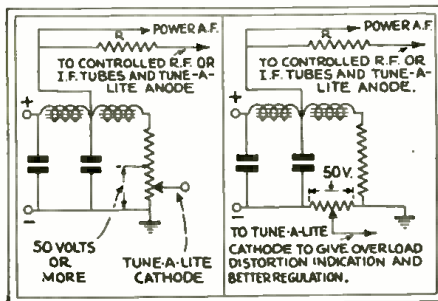

Fig. 4, left. Fundamental connections of the neon tube.

Fig. 5, right. A circuit for improved regulation.

In receivers using '45 output, the novel scheme of connections of Fig. 7 allows the tune-a-lite to act not only as a volume indicator, but also as a distortion indicator. When distortion occurs in an amplifier, the plate current kicks above its normal value, which manifests itself by a flickering of the tune-a-lite. For those receivers employing an A.V.C. tube, the circuit of Fig. 8 is suggested as a means of utilizing this latest contribution to radio.

Ripple Voltage

(Continued from page 292)

system and reduces the chances of ruining the meter.

If we have a power supply which delivers, say, 500 volts under load, and the meter range is 50 volts, then a full-scale reading would indicate that the ripple is 10% of the applied voltage.

This method requires a minimum of parts; and satisfactory approximations of the ripple voltages can be obtained.

NEED FOR EDUCATION

ANOTHER reason that the newspapers do not have to fear the radio as a rival," says "F. P. A." in the New York Herald Tribune, "is that most of us know many a home in which at least two newspapers are taken, or, as they say in England, taken in. We know some families that take two Herald Tribunes. But there won't be homes with two radio sets, at any rate not going synchronously."

Referred to the Committee for the Enlightenment of Columnists. There are now homes with two radio receivers, two motor cars, and two toothbrushes. Perhaps some public-spirited Service Man can sell Mr. Adams a volume-control attachment—for his neighbors.

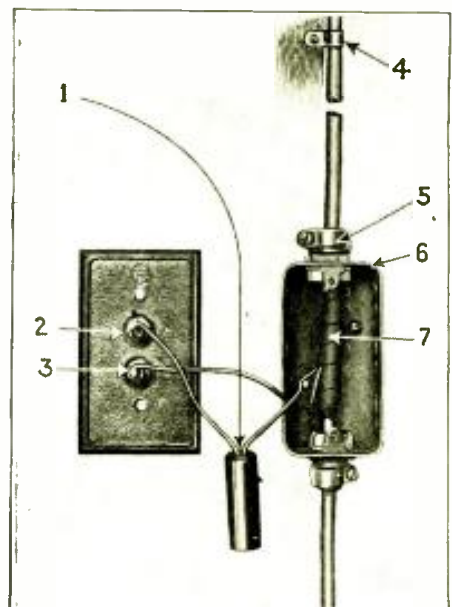

Fig. E

Radio outlet box. Rear view of cover, and front view of box; showing the "taplet" 1, and the antenna and ground connections.

of 50 outlets has been connected. However, in addition to the ground connection employed at each "antensifier," and at each line's outer end, a ground connection should be made at the lowest point on each loop, when lines are looped up and down as described above.

The ground connection should be made of No. 14 copper wire, soldered to the lead sheath and the copper ribbon directly under the sheath of the Cabloy, and should be run to the nearest cold water supply line, where an approved ground clamp should be employed in the manner recommended by the Underwriters.

For buildings of the low, spreading type, the above procedure may be employed, only in a horizontal plane instead of vertical.

Conduit and Outlets

In most new construction work, 3/4-in. metal conduit should be employed, as this

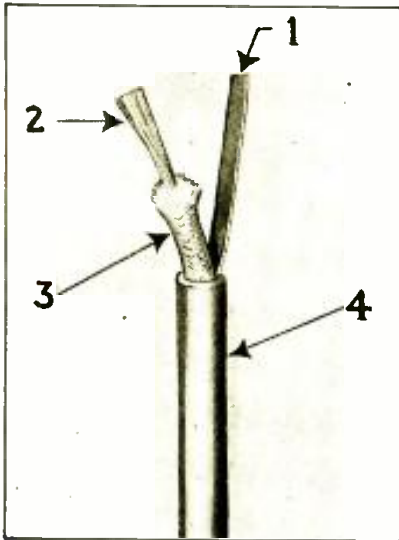

Fig. H

The "Cabloy." At 1, the copper ribbon or ground conductor; 2, cable proper; 3, cotton insulation; and 4, lead sheath.

makes for ready access to lines, ease of pulling lines, and costs approximately the same as the 1/2-in. metal conduit. Where only short, comparatively straight runs are employed, 1/2-in. conduit is satisfactory, but for long runs, and especially where bends are encountered, the 3/4-in. size will be much more satisfactory.

If desired, 3/4-in. Greenfield (flexible conduit) may be employed, or even 1/2-in. Greenfield for short, comparatively straight runs.

For surface runs, as in the case of old or existing structures, "Wiremold" or other surface metal duct may be employed. (This will be referred to later.)

For all ordinary "Radio Outlets," Fig. E, using a flush plate of the same size usually employed for a single device, any single box 1 3/8-in. deep may be used, but for the convenience of those whose duty it is to actually make the taps and splices in the cable, and to arrange the devices in place, an over-size box with a reduction cover will be found a great convenience. For this reason, a standard 4 11/16-in. square box, Fig. F, is recommended, with an aperture cover to take a single plate. The box and cover may be installed so as to mount the radio outlet plate vertically, or horizontally. It is customary, if the plate is to be located down near, or on, the base board, to mount it horizontally; whereas, plates mounted at, or near, switch-height should be installed vertically.

Terminal Devices

In many cases, it is desirable to combine the radio outlet device on the same plate with a current tap, so that 110-volt power for the radio set will be available at the same point.

In this case, a two-gang plate, Fig. G, should be provided for, with a box correspondingly large. However, care should be taken to keep the two devices isolated from each other (in the box), in accordance with the Underwriters' requirements. The power circuits (110-volt) and the signal circuits (radio) must not cross over from one side of the box to the other; and the two circuits and their devices must be separated by a metal barrier within the box. Moreover, the separable plugs which fit into these outlets must be "polarized" so that it will be impossible to confuse them, or make the mistake of inserting the wrong plug into the receptacle.

In each radio outlet, a black cartridge-like device known as a "taplet" is employed, and is connected between the center conductor of the Cabloy and the antenna terminal on the outlet plate. The "taplet" is covered entirely with insulating material, and may be conveniently "stuffed" into any available space in the box.

In the last outlet on every line, a device known as a "terminet" is also employed, and is connected directly across the end of the line from center conductor to sheath (and ground ribbon), Fig. 11. It also resembles the "taplet," (but may be distinguished by its red color) and may be placed in any convenient corner of the box.

Splicing and Connecting

In opening up the "Cabloy" for connection or splices, care should be taken to keep it free from moisture.

First, the lead sheath is carefully cut away, for a distance of about 2 1/2-in. being careful not to break or injure the copper ribbon or the center conductor. Then the cotton braid insulation is cut away for a space of about 1 in., using a pair of small scissors or snips. Next, the splice is made to the center conductor, after which the splice to the copper ribbon is made,—in both cases avoiding the use of any kind of acid flux whatever. Only rosin or rosin core solder should be employed.

As soon as the soldering is finished, the splice should be well insulated with rubber tape, running it well up over the ends of the lead sheath so as to keep moisture out of the opening. Then friction tape should be applied to keep the rubber tape in place.

All loose ends of the Cabloy should be sealed up in like manner during the installation process, so as to keep moisture out of the product at all times.

Interference Sources

(Continued from page 287)

This means of radiation is known as "copper coupling" and exists when a high-frequency current is set up in a copper circuit and carried directly by the copper to a point near the receiving antenna. It is particularly hard to locate; since the point at which the maximum of noise is picked up by the test is not necessarily the actual source of the interference.

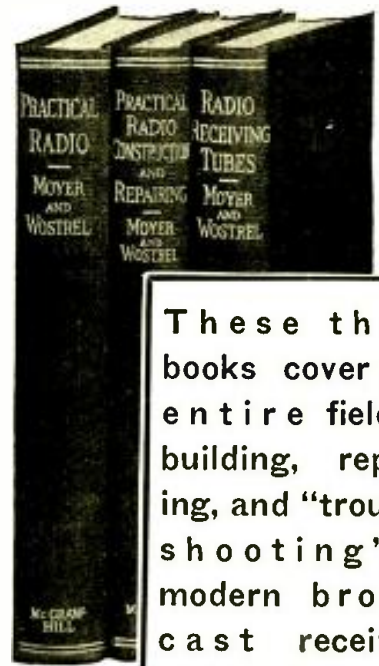

These three books cover the entire field of building, repairing, and "trouble-shooting" on modern broadcast receiving sets.

993 pages
5 1/2 x 8 inches
fully
561 illustrations

This library serves alike the needs of the commercial radio dealer, installer and serviceman, and the amateur who keeps abreast with the latest trend in radio by building his own sets.

The Library is up-to-the-minute in every respect and is based on the very latest developments in the design and manufacture of equipment. The rapidly-growing interest in short-wave reception is thoroughly covered in a complete section which deals with the construction of this type of apparatus.

Radio Construction Library

By JAMES A. MOYER and JOHN F. WOSTREL

Faculty, University Extension, Massachusetts Department of Education

Three Volumes — 993 Pages, 6x9
561 Illustrations

THESE three books embody not only a thorough home-study course, but a ready means of reference for the experienced radiotician. Step-by-step information is given on wiring, "trouble-shooting" installation and servicing to get the best tone quality, distance and selectivity in broadcast reception in all types of sets.

Practical data is given on radio equipment such as antenna systems, battery eliminators, loud speakers, chargers, vacuum tubes, etc., etc.

A section is devoted to the identification of common faults in receivers and methods of making workmanlike repairs.

The three books are profusely illustrated with understandable diagrams of hookups, connections, loud speaker units, installation work and antenna erection—as well as numerous photographs, tables and charts which clarify the text.

See this Library for 10 Days Free
No Money Down — Small Monthly Payments

It is your privilege to examine this Library for 10 days without cost. If they prove satisfactory, send an initial payment of only \$1.50 and \$2.00 a month until \$7.50 has been paid. Otherwise return the books.

McGRAW-HILL FREE EXAMINATION COUPON

McGRAW-HILL BOOK COMPANY, INC.,
370 Seventh Avenue, New York.

Gentleman:—Send me the new RADIO-CONSTRUCTION LIBRARY, all charges prepaid, for 10 days' free examination. If satisfactory I will send \$1.50 in 10 days, and \$2.00 a month until \$7.50 has been paid. If not wanted I will return them at your expense.

Name

Home Address

City and State

Position

Name of Company.....RC-11-31

The Design of Large Installations

(Continued from page 277)

figures. (Actual figures are tabulated on page 297, of this issue.—Tech Ed.) The most important use of the decibel is when it is desired to change from power in "watts" to "decibels." Most measurements are made as per so many "DB up" or so many "DB down." In other words, a certain volume level is taken as a reference or zero level and all measurements made are in relation to this position.

For the sake of simplicity, suppose that we regulate the volume of a radio set to that position that gives us the most pleasing response to our individual ears. Then we can call this volume our reference or zero level, and if we advance the position of the volume control, then we go so many DB up, or if we retard the volume control so as to cut the volume, then we go so many DB down from our fixed zero level position. We have changed the volume by either adding or subtracting resistance through the volume control. Now if we take our reference or zero level and find the power required to give us this value in milliwatts, then we can easily derive a ratio between our reference value and any new value that we may care to set up by either advancing or retarding our volume level. However, we have been dealing only with ratios of power in watts. To change our watt ratio to decibels, it is only necessary to multiply the common logarithm of the watt ratio by

10, and our result will be directly in decibels. The "V.I.", or volume indicator meter, is usually designed so that the zero position of the meter is in the exact center. When a signal is put through the instrument it will designate zero level when the needle is on this zero mark. If the volume is increased or decreased, the amount in DB is readily ascertained by reading the position of the needle and adding this figure algebraically to the value indicated on an

very recent date used 10 milliwatts as their value for voice transmission. Another large corporation used 12 milliwatts, and still another, 6 milliwatts. In order to bring about a general standardization, the Stromberg-Carlson Company reduced their value to 6 milliwatts, a value now generally accepted as standard. (Note 3 will show the manner in which the DB calculations for this installation are made.)

To return to our guest room reception, it follows, that to accurately gauge the volume in these rooms, the use of some type of level indicating device is imperative.

In general there are two methods of measuring the sound "level." One makes use of the well-known vacuum tube voltmeter principle, and the other uses a D.C. meter operating in conjunction with a "copper-oxide rectifier." In both cases, the devices are connected directly across the lines through which the level is to be measured. The copper-oxide rectifier rectifies the applied A.C. input which is then applied to the D.C. meter, and the "level" is then read.

The disadvantages of this type of indicating device are that the current passing through the rectifier introduces a slight error that is greatest at the -10 decibel mark, where it may be as large as 1 decibel. Also, an instrument of this type is usually calibrated for a definite line impedance. If used across any other value of line impedance the readings must be corrected. At-

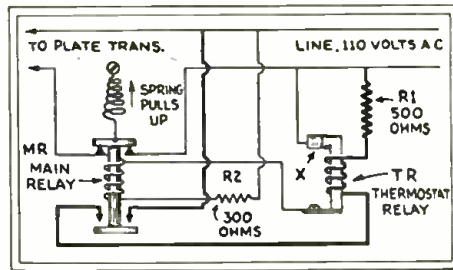

Fig. 3

Diagram of the thermostatic "time-delay" relay.

attenuator connected to the input posts of the V. I.

One great difficulty that now seems to be disappearing, is in deciding at just what value the reference or "zero level" should be taken. It would be best, of course, to choose a figure that would be acceptable to all radio and electrical engineers.

The Stromberg-Carlson Company, up to

Thinking of Making EXTRA Money in spare time?

Servicing Electric Refrigerators Brings Many Easy Dollars

\$5.00 The Copy

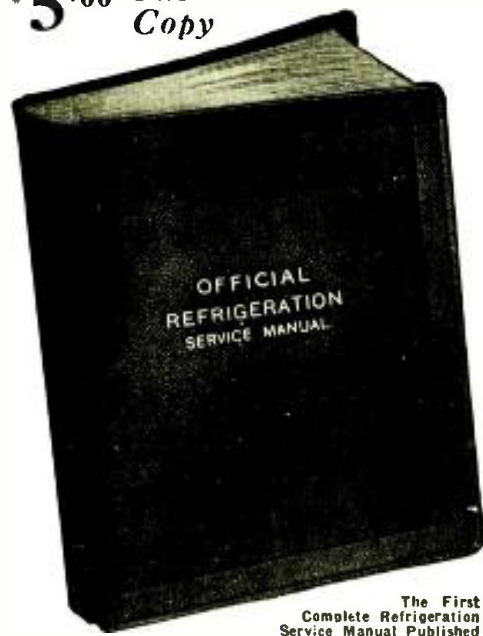

THE idea of electricians, radio service men and other mechanically inclined men, servicing refrigeration units is self-evident and the thought has occurred to perhaps untold thousands ever since electric refrigeration started. Yet nothing was done, because the average man knows little or nothing about refrigeration. Compared with servicing a radio set or wiring a home for electricity, the servicing of a refrigerator is absurdly simple, once you get the hang of it.

The OFFICIAL REFRIGERATION SERVICE MANUAL has been edited by L. K. Wright, who is an expert and a leading refrigeration authority. He is a member of the American Society of Mechanical Engineers, American Society of Refrigeration Engineers, The National Association of Practical Engineers, etc.

In this Refrigeration Manual every page is profusely illustrated; every refrigerator part is carefully explained; diagrams are furnished of every known machine; special care is given to the servicing end. The tools needed are illustrated and explained; there are trouble shooting charts, and other service data.

Remember there is big money in the refrigeration servicing business. There are thousands of firms selling refrigerators every day and they need to be cared for often. Eventually there will be more refrigerators than radios. Why not increase your earnings with a full or spare time business by servicing refrigerators.

OVER 1,000 DIAGRAMS
352 Pages
Flexible Looseleaf Binder
Complete Service Data

Here are some of the important chapters:

- Introduction to the Refrigeration Servicing Business
- History of Refrigeration
- Fundamentals of Refrigeration
- Description of All Known Types of Refrigeration
- Service Tools and Shop Equipment
- Motors
- Trouble Shooting
- Valve Parts, Valves and Automatic Equipment
- Makes and Specification of Units
- Manufacturers of Cabinets
- Refrigerants and Automatic Equipment
- and Many other Important Chapters.

Already hundreds of copies of the OFFICIAL REFRIGERATION SERVICE MANUAL have been sold; and there still remains the greatest opportunity for thousands more to learn how to make money in a short time through openings in this new field.

Mail Coupon Today!

GERNSBACK PUBLICATIONS, Inc. R-11
96-08 Park Place, New York, N. Y.

I enclose herewith my remittance for \$5.00 (check or money order preferred) for which you are to send to me, postage prepaid, one copy of the OFFICIAL REFRIGERATION SERVICE MANUAL.

Name

Address

City State.....

other objection is that it draws an appreciable current where it is used across a circuit in which it is desired that the current drawn be negligible. As the use of this instrument is primarily designed for line level checking and not for precision laboratory work, the latter can usually be neglected.

The advantages of such a device are that the unit is extremely flexible and portable so that it may be carried around and used anywhere. No batteries or tubes are required. This reason in itself is sufficient to justify the almost universal use of the oxide-rectifier type of level indicator.

The Vacuum-Tube "V.I."

The second type of indicator, or "vacuum tube voltmeter" instrument, is, however, the ideal for level measurements, in that it does not add any appreciable load to the network; and is also quite accurate. In Fig. 4 is shown the schematic circuit of the vacuum tube voltmeter type of "V.I." It will be noted that the input to the grid of the tube is obtained through a transformer. Naturally, therefore, a system of this kind will draw current from the line. However, where it is desired that no current be drawn, the input (grid) can be connected directly to the line without the use of a coupling transformer.

The V. I. is usually so arranged in standard volume indicators, that three ranges of operation are available. This is accomplished by means of a three-way key-switch which, when placed in the lower position, can be used for levels up to about 5DB; in the middle position, up to 15 DB, and; in the top position, it is designed for operation on levels up to approximately 30 DB.

It is desirable to use a tube with a high mu or amplification factor, because of the greater output change possible. For this purpose, therefore, the Western Electric Company uses their type "102D" tube, which is about equivalent to the standard "UX-240." (In the New Yorker, the UX 240 is used exclusively.)

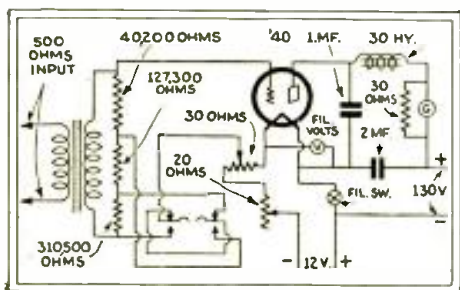

Fig. 4

A schematic diagram of a volume-level indicator based on the vacuum-tube voltmeter principle.

The tube instead of being operated "on the straight portion of its static characteristic" (to give undistorted output) is operated on the "lower bend" or "knee." This results in a non-linear ratio of input-to-output power which is, of course, to be desired in a device of this type. It will be noted that in the plate circuit of the "V. I." tube, there is a filter arrangement, for the purpose of smoothing out the current fluctuations in the plate circuit. The pointer of the meter does not follow all variations, but follows quite nicely most of the current peaks. It would be undesirable to have

the pointer follow all fluctuations for it would then be quite impossible to follow it.

To dampen or slow down the pointer action still further, the galvanometer is shunted by a 30 ohm resistor.

In practice the volume indicator becomes an indispensable piece of apparatus. It is used for a great many purposes. In the New Yorker, aside from functioning as a level indicator for radio signals going to guest rooms, the V. I. is also used for keeping the line level constant at .006-watt on programs originating in the hotel and either going out to the N. B. C., or going through the hotel amplifying system with an ultimate termination in the guest rooms or other public rooms. Also, the V. I. may be calibrated to read A.C. voltages, and in this manner may be utilized to read a variety of voltages.

NOTES

1. Manufactured by Stanley & Patterson, New York City.
2. Manufactured by Struthers & Dunn., Philadelphia, Pa.
3. The formula for DB is:

$$DB = 10 \text{ LOG}_{10} \left(\frac{\text{PWR. IN WATTS}}{\text{REFERENCE VALUE OR ZERO LEVEL}} \right)$$

Assuming that we use 10 milliwatts as our reference value, for it was this figure that was used by the Stromberg-Carlson Company in the original design of the Hotel New Yorker, then, as each speaker is designed to draw 50 milliwatts, our guest room decibel figure is:

$$DB = 10 \text{ LOG}_{10} \left(\frac{.050}{.010} \right) = 10 \text{ LOG } 5.0$$

The Log. of 5.0 is (0.698), thus, our DB=10 X .698=6.98 or approximately 7 DB as the "guest room level," using 10 milliwatts as our "zero level." Supposing the DB value of a standard W.E. "43A" amplifier is desired, the output of which is rated at 12 watts (undistorted). Let us use the now generally accepted value of 6 milliwatts as our reference figure. Then,

$$DB = 10 \text{ LOG}_{10} \left(\frac{12.}{.006} \right) = 10 \text{ LOG } 2000.$$

The characteristic of 2000.00 is 3. The Mantissa=.30103 or the Log of 2000=3.30. Our DB value therefore is: DB=(10)(3.30)=33.0.

If, however, we desired to add another W.E. "43A" Amplifier in parallel with the first, then our output wattage would now be doubled, or 24 watts, but the DB value would only be:

$$DB = 10 \text{ LOG}_{10} \left(\frac{24.}{.006} \right) = 10 \text{ LOG } 4,000.$$

The Log 4000=3.6020. Therefore, DB=10 X 3.6=36 DB or an increase of only 3 DB.

THE PENTODE PORTABLE STEPS OUT
Editor, RADIO-CRAFT:

Having just completed the AC portable, described in the September, 1931 issue of RADIO-CRAFT, I wish to express my opinion on this mighty little receiver, not having expected half the results which this little has shown.

I just couldn't keep the amazement to myself. Everyone I spoke to about the volume and simplicity of this set has doubted me till they actually saw and heard for themselves; but that isn't all.

Last night as I was about to "turn in" I listened to a snappy program and when it ended I was surprised to hear the call letters WOWO, Forty Wayne, Ind; a station which cannot be received under the best condition with my big set using 4 R.F. stages! Well sir, that fired my curiosity for what else it could do; and WTAM, WPG, WRVA, WIP, and a few more just rolled in.

JOHN A. NYRE,

71 Randolph Ave., Jersey City, N. J.

Mr. Service Man:

Follow radio's leading engineers and adopt

POLYMET PRODUCTS

Standard of the Industry

These finely built parts are used by practically all leading receiver manufacturers. By standardizing on *Polymet*, you can safely give *Guaranteed Repairs*—increasing both your business and prestige.

Polymet has only one quality—the very highest. These reliable parts, at reasonable prices, can be purchased direct from the factory, or from the better dealers and radio mail order houses.



Type UK-25 Unsealed Condenser Kit, for filter block repair work.

Ask for description of this most useful kit ever assembled for service work. We will include free our special Service Men's Catalog, containing many service helps.

Polymet Mfg. Corp.

World's Largest Manufacturer of Radio Essentials

829 East 134th Street, New York City



Model "BB"
List Price

\$25.00

THE NEW HEAVY DUTY Model "BB"

—The Talk of the Radio Industry!

The masterpiece in microphone construction. Halftime precision. Nearly twice as heavy as any other microphone of its size. Extra Heavy 24 Kt. Pure Gold Spot Centers. Duralumin diaphragms. Three degrees of sensitivity. Fully guaranteed.

UNIVERSAL MICROPHONE CO., LTD.
1163 Hyde Park Blvd. Inglewood, Calif.

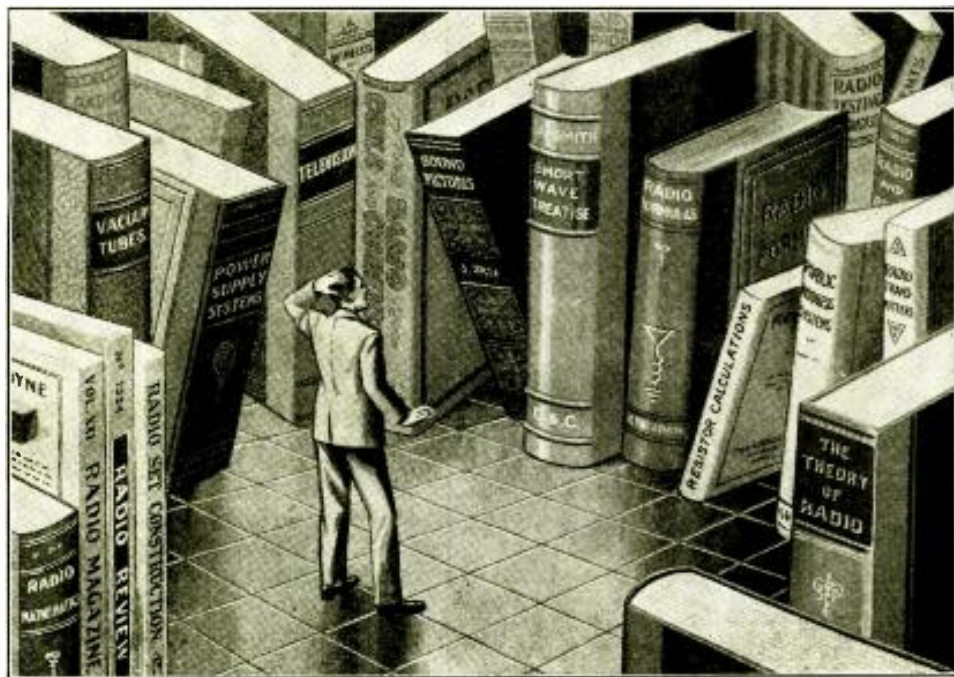

Did This Ever Happen to You?

You want to get the exact and technical meaning of a word or phrase in radio! You are in doubt about a radio formula or radio circuit! You look through a maze of books and magazines losing your time and your temper.

Why not have at your desk or in your library a copy of

S. GERNSBACK'S RADIO ENCYCLOPEDIA

IT gives you an explanation of every word in radio. These explanations—or, rather, definitions—are not brief outline information like those of an ordinary dictionary, but they give in fullest detail, and at considerable length, the meaning and application of every word, phrase, general and special term used in the science of radio. They are written in plain, everyday English, easily understood by anyone.

Practically every definition in the book is illustrated by drawings, photographs, diagrams, or charts. All you need to do is to look up as you would in a dictionary, the word or phrase about which you are seeking information. Furthermore, each page is key-indexed, for greater convenience and speed in locating any definition. ALL THE SUBJECT-MATTER IS ARRANGED IN ALPHABETICAL ORDER.

Numerous tables, charts, and maps are distributed throughout the text. A large section of the Appendix contains information of commercial value, such as lists of all radio receivers, their manufacturers, trade names, tubes used, styles, etc. There are charts of tube-socket lay-outs of all makes of sets; broadcast stations listed by wave-lengths, call letters, towns and states, etc.

In the text you will find biographical notes, with portraits, of all the men who by their inventions, discoveries, and research, have made radio what it is today. Large sections of the text are devoted to such important subjects as television, troubleshooting, servicing, short-wave reception and transmission, testing instruments, sound projection, etc.

Full descriptions are given of all vacuum-tubes, the theory of their construction, characteristics, testing and manufacturing.

The latest inventions, such as the Radio Knife, Ultra-short waves, Variable-Mu tubes, and locating treasures by radio, are as fully described by word and picture as are the old-time Marconi coherers and detectors.

It took a large staff of editorial assistants and draftsmen over six months to assemble, classify, and illustrate all the material printed in this book.

Mail Coupon TODAY!

S. GERNSBACK CORPORATION RC-II
98 Park Place, New York, N. Y.

Kindly send me one copy of the new Second Edition S. Gernsback Radio Encyclopedia. I enclose herewith \$3.98, check or money order preferred. (Foreign and Canada, add 35c extra for postage.) If the book does not come up to my expectations, or is not as represented, I can return it, and have my money refunded in full.

Name

Address

City..... State.....

The new 1931 Second Edition is a volume of 352 pages. It is a large book 9 inches wide by 12 inches high, and weighs three pounds. There are 2,201 radio definitions, ABC indexed like a dictionary, or any other encyclopedia, making every bit of radio information you want "findable."

The new book contains 1,253 detailed technical illustrations, 34 tables and charts, and 24 pages of Appendix, etc. The binding is flexible red morocco-keratol, with title gold-stamped on cover and backbone. The text is printed on durable, fine ledger paper, and the loose-leaf construction permits of new material being added, such as notes, addenda data, etc.

Why You Should Own This Invaluable Volume

THIS greatly enlarged Second Edition Radio Encyclopedia is an absolute necessity to everyone interested in Radio. It answers all radio questions, increases your knowledge, and saves your time. It covers every known radio problem, and is a gold-mine of practical information for every radio man.

- It is of equal service to:
 - The Radio Engineer, who wants to refresh his memory on formulas and circuits;
 - The Radio Manufacturer, Jobber, and Dealer, who is interested in the commercial side of radio as well as the technical;
 - The Radio Service Man and the Radio Constructor, who wants to have on hand a guide to the principles and design of radio equipment;
 - The Radio Student and the Layman, who will find the whole theory and practice of radio explained here in the simplest terms, beginning with the first principles and leading up to the most advanced theory.

\$3.98

THIS book is the NEW 1931 EDITION OF THE FAMOUS FIRST RADIO ENCYCLOPEDIA by S. Gernsback, the first book of its kind ever published in America.

The new Second Edition—just off the press—is fully revised, rewritten, and enlarged. It is the absolutely up-to-the-minute new model of the pioneer First Radio Encyclopedia, which became the stand-by of all radio men in every part of the world.

39,000 Bought the First Edition!

Magic in Meters

(Continued from page 280)

when it is heated. The wire A-B is connected to the source of radio frequency current, the heat of which expands the resistance wire. Spring S, through thread T, exerts a pulling action on this slackened wire, the resultant motion causing the needle N to move over the scale. The degree of movement depends upon the amount of current flowing in the wire, A-B, as shown at A, Fig. 7.

Any instrument which will measure electricity in small quantities may be called a galvanometer, but the general definition is that it is a magnetic device used merely to indicate the presence of electricity in a circuit.

The Tangent Galvanometer

A simple type of galvanometer is shown in Fig. 8 and is known as a "tangent" galvanometer. (The genesis of this term lies in the fact that the current strength is proportionate to the tangent of the needle's deflection.—Tech. Ed.) Briefly, it consists of a magnetic compass laid horizontally within a form on which is wound a coil of fine wire.

When the coil is not connected to a battery, the magnetic needle of the compass will point North and South, drawn by the attraction of the earth's magnetic poles.

If the coil is placed in a vertical position, as shown in Fig. 8, and a current passed through the coil, the degree of deflection will be a function of the intensity of the current flowing in the circuit.

The device is quite accurate and may be calibrated by passing through it known quantities of electricity, and noting the respective positions of the magnetic needle on the scale. Ninety degrees on the scale, in either direction, left or right, is the limit of usefulness of this device. If, for instance, the passage of 2 amperes through the coil causes the needle to deflect 80 degrees, then a deflection of 45 degrees represents some lower value of current.

The reversal of the applied potential will cause a change in direction of the needle's movement. Thus, the device can be used to indicate "polarity."

For those interested in experimenting, the coil can be made up in several sections having leads so that the section can be brought out to binding posts, in order that the coils may be used singly, in series, or in parallel, as desired.

D'Arsonval Movements

Today, galvanometers are made with a large "permanent" magnet (so called) of horseshoe shape, with the coil of wire mechanically supported on "jewelled" bearings so that it is free to turn between the pole faces of the magnet.

When the current passes through the coil, the magnetic lines of force formed around the coil cause it to turn, with a tendency to enclose as many of the lines of force as possible. This construction is known as the "D'Arsonval" type, and forms the basis for our standard types of D.C. voltmeters and ammeters. Figures 9 and 10 show the mechanical design and the electrical circuit; and A, a photograph of this most important contribution to the meter art.

It is interesting to note in this type of instrument the results obtained when its two magnetic fields are combined; such as the circular field produced by an electric current flowing through a wire, and a parallel field produced by two permanent magnets, Fig. 11. Here it will be seen that the lines of force are crowded together on the upper side of the wire and tend to force it down. (This principle underlies the operation of the electric motor, as well as measuring instruments.)

The permanent magnet type of D'Arsonval movement (illustrated in Fig. 12, with the poles marked N and S), is of the common or horse-shoe shape. The coil A-B (Fig. 12) is held to the structure in such way that it can freely revolve.

The current which is to be measured is led into the coil via the springs in such a

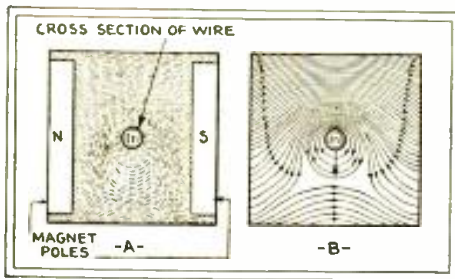

Fig. 11

Magnetic field between the two poles of a permanent magnet at A; and at B, the distorted magnetic field when the wire is carrying current.

way that it goes in at B and out at A. The field set up around wire B strengthens the field of the permanent magnet N-S above the wire B, and weakens it below, thereby forcing the wire B downward. At the same time, wire A sets up a field which strengthens the field of the permanent magnet N-S below A, and weakens it above, thereby forcing wire A upward. This ac-

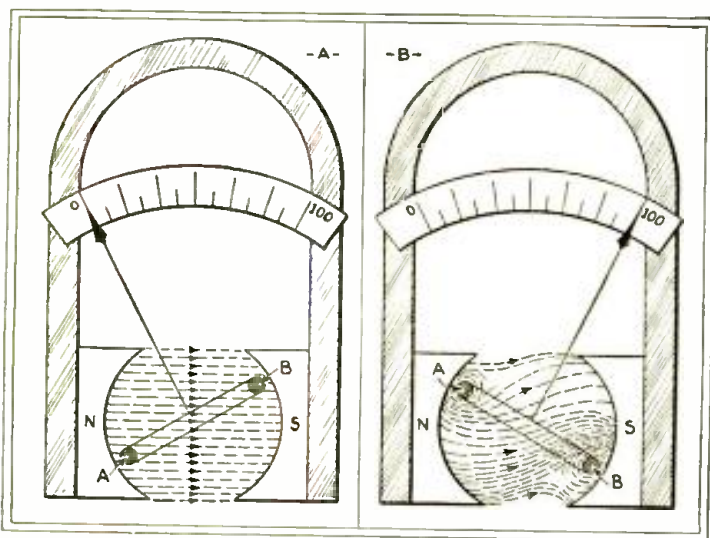

Fig. 12

At A, left, the field distribution in a D'Arsonval movement when the moving coil is not carrying current; at B, right, the field distribution when the moving coil is carrying current.

magnet to the same extent. This results in equal increases in deflection for equal increases in current throughout the entire scale.

Calibration

The "arc," or portion of the circle through which the pointer swings, in this type of instrument depends on the strength of the magnetic field set up in wires A and B— which, in turn, depends upon the current flowing in the coil.

For instance, if the scale were to be calibrated in units of current, let us say milliamperes (thousandths of an ampere), we would have a millimeter. It is possible that the scale could be calibrated in volts and the meter used as a voltmeter, for the resistance of the wire A-B is constant, and the current through the coil would be proportional to the voltage across the terminals A-B.

Thus, by winding the coils with any one of various sizes of high-resistance wire, a definite value of resistance can be obtained for the coil, and meters for measuring small or large quantities of electricity will result.

In commercial instruments, resistance, R1, in Fig. 9, is placed in series with the moving coil, and is called a "calibrating" resistor.

This furnishes a means for compensating any inaccuracy in winding the coil, and permits quick and accurate calibration; otherwise, it would be necessary to undertake the laborious job of removing or adding turns of wire to the moving-coil (as in the very first instruments) in order to obtain correct scale indications.

Future Articles

So far, we have only skimmed the high spots in the development of the modern electric meter. Many methods of interest to the laboratorian are being omitted for lack of space, and the fact that they play but a small role in the steady progress of radio meter design.

tion rotates the coil so that the needle (rigidly attached to the coil) swings across the scale.

It should be noted that the coil and the pointer are mounted at right angles to one another. This is done so that, as the pointer swings over the 0 to 100 scale, the moving coil (swinging through the same angle) always distorts the field of the permanent

Looking at a modern commercial meter we cannot conceive the labors of those men who spent their lives to conquer the measurement of that force, "Electricity."

In articles to come, the modern test instruments of all types will be described as to the theory of operation, their use, and short sketches as to how they were developed.

Radio Television

The good jobs in any profession are held by the better-than-average men—the men with technical engineering training.

The leaders in radio today are the men who were STUDYING radio ten years ago. The leaders in Radio and Television tomorrow will be the men who are seriously preparing today.

We offer Advanced Courses in Practical Radio and Television Engineering for the experienced radioman—Complete Courses in Practical Radio and Television tomorrow will be the men experienced radioman.

Send in the coupon for complete details TODAY.

Capitol Radio Engineering Institute
Riggs Bank Bldg., 14th & Park Road, N.W.
Washington, D. C.

Please send me without obligation complete details of the following course: (Check course).

- Advanced course in Practical Radio Engineering
- Complete course in Practical Radio Engineering
- Advanced course in Practical Television Engineering
- Complete course in Practical Television Engineering

Name

Address

.....(Nov. RC.)

SERVICE MEN Send for this Book



FREE!

YOU NEED IT!
Everything for your business from the finest mike to the smallest screw is in this book.

GUARANTEED QUALITY GOODS
PRICES LOWEST EVER QUOTED
Fresh new dependable Merchandise at Bargain Prices!
Leading Manufacturers Lines Complete
Send For Your Copy Now!
HEADQUARTERS
for **SERVICE MEN'S SUPPLIES**

RADOLEK CO.
601 W. Randolph St.
CHICAGO
Illinois

USE THIS CONVENIENT COUPON
Please send me without obligation your Service Man's Supply Book.
Name
Address
City State



THE NEW HOTEL LINCOLN
 EIGHTH AV.-44th 45th STS.
 Just a Step from B'way
 NEW YORK CITY

The New and Beautiful
HOTEL LINCOLN
 You are assured of MAXIMUM COMFORT and MAXIMUM SERVICE

1400 Rooms, each with tub and shower-Servidor

SINGLE:
 \$3.00, \$3.50, \$4.00, \$5.00

DOUBLE:
 \$4.00, \$5.00, \$6.00, \$7.00

RADIO—DeForest Direct—now being installed in every guest room

ROY MOULTON
 MANAGER



A riotously gay new revue at **Connie's Inn** featuring the finest in colored entertainment! Dance-compelling music by Fletcher Henderson and his orchestra.

CONNIE'S INN
 131st St.—7th Ave., N. Y. C.
 Tel. Tillinghast 5-8630

The Service Forum
 (Continued from page 281)

What the constructor needs to help to revive interest is a real "Roll Your Own." I think a set with the following features would make an ideal receiver: One stage of R.F. ahead of the detector; first detector; oscillator; three stages of I.F., tuned to 175 kc.; second detector, using "C" battery. The audio end could be left to the discretion of the builder.

As a receiver using two dials is more efficient than one with single control, a double-drum dial would be used; the R.F. stage and first detector on one side, and the oscillator on the other.

By using three I.F. stages, it becomes a simple matter to reduce the amplification, when desired, by simply removing the control-grid lead from the cap of the first tube, and placing it on the second.

For the "A" voltage, it would be advisable to use one cell of a storage battery, as almost everyone has one of these lying around. The connectors could be cut, the three cells connected in parallel and, in this way, the battery would give long service before recharging.

Everyone is talking superhets now, so I think the new tubes are going to help the situation. Let us hope you will consider publishing an article on the construction of a receiver, such as I have suggested.

A. E. ELLISON,

P. O. Box 130, Hicaco, Wash.

(The superheterodyne Mr. Ellison has in mind seems to be rather one for the experimenter's own use than for sale to a broadcast fan. How many of our readers would like to see an article on a set of this nature?)

The suggestion on the conversion of a 6-volt storage battery for use with 2-volt tubes will interest many readers. However, the two-volt tubes were made for dry-cell or air-cell operation; and the constructor who has current at hand to keep his battery charged up may do better to use the more efficient and powerful '24s, '35s, '27s and '17s.—Editor.)

Resistor Guide
 (Continued from page 275)

to each and every job. To overcome this difficulty, the International Resistor Company has compiled a very compact booklet which lists the different model receivers (using resistors) of over 35 set manufacturers and describes the correct replacement resistors.

This booklet lists ten fundamental circuits in which resistors may be used; and most of the formulas that are directly connected with resistance calculations. Following this, there are tabulated (for each manufacturer) the troubles that may be due to poor resistors; the purpose of each resistor and its points of connections; and the resistor's color code, its value in ohms, and the recommended replacement value.

Due to the small size of the book, it should be found in the pocket of every Service Man. For further information, write to the International Resistance Company, 2006 Chestnut Street, Philadelphia, Pa.

Classified Advertisements

Advertisements in this section are inserted at the cost of ten cents per word for each insertion—name, initial and address each count as one word. Cash should accompany all classified advertisements unless placed by a recognized advertising agency. No less than ten words are accepted. Advertising for the December issue should be received not later than October 9th.

FORMULAS

MAKE AND SELL your own products. We will furnish you any formulas. Write for our literature. Chemical Institute, 19R Park Place, New York, N. Y.

RADIO

SERVICE MEN, ATTENTION—Speakers re-wound, magnetized, repaired, \$2.00 to \$2.75. Complete Power Pack Service—Transformers rewound, condenser blocks repaired, resistors duplicated. Guaranteed. Clark Brothers Radio Co., Albia, Iowa.

SERVICE MEN double your business and pile up the profits with our new plan for procuring business. For free particulars write, R. Roose, Louisville, Kentucky.

SERVICE SHOPS—we specialize in rewinding power transformers. Try us. Supreme Radio Laboratory, 16 Fulton Avenue, Rochester, N. Y.

BENCH LEGS—angle iron—shipped knockdown—for work and display—\$3.00 up. Kirk Hardware, Dept. 308, 128 East 23rd Street, New York City.

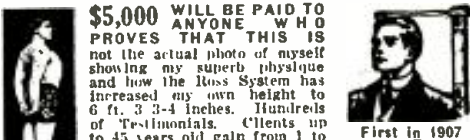

\$5,000 WILL BE PAID TO ANYONE WHO PROVES THAT THIS IS NOT THE ACTUAL PHOTO OF MYSELF SHOWING MY SUPERB PHYSIQUE AND HOW THE ROSS SYSTEM HAS INCREASED MY OWN HEIGHT TO 6 FT. 3 3/4 INCHES. Hundreds of Testimonials. Clients up to 45 years old gain from 1 to 6 inches in a few weeks!!

First in 1907 First To-day

No Appliances—No Drugs—No Dieting. ROSS SYSTEM NEVER FAILS. Fee Ten Dollars Complete. Convincing Testimony and Particulars 5 cents stamps. Allow time for return mails across the Atlantic. G. MALCOLM ROSS, Height Specialist, Scarborough, England, (P. O. Box 15).

A Special Offer to NEW READERS

Eight months' subscription to **RADIO-CRAFT** for **\$1.00**. Send remittance to **RADIO-CRAFT, 98 Park Place, New York, N. Y.**

(Canadian or foreign not accepted at this rate.)

HEADQUARTERS

for all

RADIO SERVICEMEN'S SUPPLIES

We carry the largest supply of replacement parts and general radio parts in the mid-west. Our store is the rendezvous for radio servicemen who will always find the latest and the best in radio merchandise in stock. We specialize in replacement transformers, condensers, resistors and volume controls for all makes of radio sets.

Be sure to drop in and see us when you are in Chicago.

NEWARK ELECTRIC CO.

A Radio Service Institution

229 West Madison St. Chicago, Ill.

Protect the Midget Set!

Midgets are designed to operate on 110 volt lines and will not stand up on higher voltages.



Save the set—save your reputation!

Install a 30-watt CLAROSTAT AUTO-MATIC LINE VOLT-AGE REGULATOR. Retail \$1.75 Price \$1.15

Other Sizes for Other Receivers

Clarostat Mfg. Co. Inc. 285 N. 6th St. Brooklyn New York

ALUMINUM BOX SHIELDS

Genuine "ALCOA" stock, silverdip finish. 5 x 9 x 6, \$1.89—14 x 6 x 6, \$3.85, 10 x 6 x 7 Monitor size \$3.25, 5 x 5 x 5 Coil Shield (like picture on right) \$1.00.

Any Size to Order.

Pentode adapters, \$1.25. Patent Pick-up heads, only \$2.25. Flexible shafts for Auto Sets.



"BUDDY" TEST PROD

Always sharp pointed, using phonograph needles, 4-ft. wires, spade or phone tips. Colored nipples identify each lead. \$1.50 pair.

We specialize in radio parts exclusively—parts furnished for any kit in any magazine. Please include Postage.

BLAN, THE RADIO MAN, Inc. Dept. RC-1131 New York, N. Y. 89 Cortlandt St.

6 FUSES in ONE PLUG

Agents & Distributors Making Big Money

A necessity everywhere. A "turn to the right brings back the light." Safe, economical, dependable. 6-in-1 Fuse Plug. Most useful invention in years. Many of our distributors in exclusive territory making \$500 to \$1000 a month. Easy to demonstrate. Easy to Sell. Profits begin right away. Write at once for proposition. Send 25c for sample and working instructions. 6-in-1 Fuse Co., 801 W. Madison St., Dept. 119 Chicago

LYNCH Resistors

Precision Wire Wound 1% Tolerance and 3 Watts

Using New "K" Filament

Write for NEW illustrated catalog

LYNCH MFG. CO., Inc. Dept. RC. 1775 B'way, N. Y.

PATENTS — TRADE MARKS

All cases submitted given personal attention by members of the firm. Information and booklet free.

Patent Office and Federal Court Practice

Lancaster, Allwine & Rommel

Patent Law Offices

475 OURAY BLDG., WASHINGTON, D. C.

A Service Bench

(Continued from page 283)

glow tube, one 10 watt incandescent lamp, and two 300 watt incandescent lamps in parallel. This condenser test set uses 3-point Hubbell plugs for external connections—which are located at the front of the bench. On the small, black board, which rises above the bench, there are various controls built up in two-gang switch plates, which control the dynamic speaker, the magnetic speaker and the output meter. Under the bench is a complete Westinghouse radio receiver chassis and power pack. The connections from this receiver are brought into the back of the bench via Yaxley connectors. This arrangement facilitates the testing of either a chassis or a power pack, without

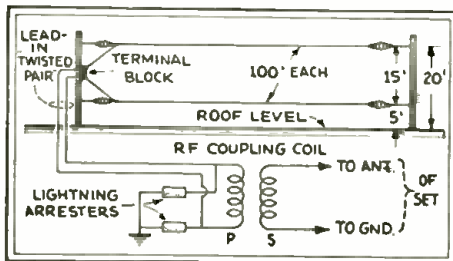

Fig. 2

The antenna-and-counterpoise construction recommended.

the necessity of having the Service Man return both parts.

The entire bench is supplied with both 110 and 140 volts A.C. through a line control-box which is located on the wall at the left-hand end of the bench. This control-box contains a 125 watt, 20 to 40 volt transformer, which is connected as an auto-transformer in order to increase the line voltage. The change in voltage is accomplished by means of a three-pole switch.

Among the other pieces of service apparatus are a pre-heater and field supply built into a steel cabinet; a complete phonograph turntable, pickup and amplifier; an RCA Model 106 loud speaker and an RCA Model 100 loud speaker. All of these are controlled by the switches located on the back panel. A battery-operated short-circuit tester for tubes is also included as part of the equipment.

A very novel antenna arrangement is used that has been found to be very efficient in this location. The diagram is shown in Fig. 2 and is self explanatory.

SYNCHRONIZING ALL SYSTEMS

THE Bureau of Standards, announcing a prospective extension of its service of standard-frequency transmissions, hopes that ultimately standard frequencies will be transmitted twenty-four hours every day; when, it is anticipated, stations may be directly controlled by the received standard-frequency signals, in effect putting all of the stations of the country on a single control. This, it is said, will be more practicable than synchronization of broadcasting stations.

Consideration is being given to placing a sixty-cycle modulation on the transmissions, with a view to aiding electric power systems to accurate synchronization; in order to advance the interconnection of electric power supply systems in various parts of the country and also to improve the accuracy of electric clocks.

EVERY RADIO SERVICE MAN should read this book which tells you how to make more money out of radio service. There are secrets which "old timers" have learned through years of experience. You can now have the benefits of these. You don't pay a penny—you don't promise to pay any—for this book will be sent to you without any obligation of any kind with our compliments if you will sign and send in the coupon. It is part of our plan to help independent radio men profit by the experience of others in the industry and make a bigger income.

Brim Full of Facts

This book was written by a man who has probably had more experience than any one else in the industry. It tells you in simple language the principles and practices which made him the outstanding figure in the radio world that he is today. These are a few of the subjects fully covered: Selling the public on radio service—Value of Personality—Newspaper advertising—Business literature—Types of service letters—Electric signs—Making tubes business builders.

This book is for service men only and will be sent FREE and fully post paid upon receipt of the coupon completely filled in.

RADIO SERVICE MEN'S GUILD
1257 Fullerton Avenue
Chicago, Illinois.

You may send me your book "Making Money Out of Radio Service" absolutely FREE and fully post paid. (Please answer these simple questions):

What radio training have you had?.....
No. of years in radio?.....
Do you give radio all your time?.....
Have you a store?.....
Do you work for some one else, if so who?.....
Name
Address
City State.....

NOT ONE RADIO SERVICE MAN IN TWENTY KNOWS THIS SIMPLE FACT . . .

but the ones who DO are on their way to better jobs and more money!

Resistors come in more than 400 values. Yet exactly 24 meet 90% of replacement calls. Do YOU know what these 24 values are? Make up a list of your own—now. Then compare it with facts our recent check-up uncovers. SEE how near right YOU are. Just send your name and address on a postcard to

TILTON MANUFACTURING CO.*
17 East 26th Street New York

but DO it—before you turn this page. You'll also receive tested, money-making hints for USING this knowledge to make your business easier!

*Tilton Mfg. Co., 17 E. 26th St., N. Y., is headquarters for guaranteed precision resistors, and EX-STAT Ignition Filter Systems for auto-radio. Write for full information.

PATENTS

Write for Free Guide Book, "HOW TO OBTAIN A PATENT" and Record of Invention Blank. Send model or sketch and description of your invention for our Free Opinion whether it comes within Patent Office Rules. RADIO and ELECTRICAL Cases a Specialty. Prompt, Efficient Service

PAYMENT OF FEES IN INSTALLMENTS

VICTOR J. EVANS & CO., 923 - 9th, Washington, D. C.

"The Short Wave is the most important thing in Radio."

Giuglielmo Marconi



On All Large Newsstands 4-Color Cover 9" x 12" in Size Over 200 Illustrations

RAPIDLY increasing each day are the number of experiments in the Short Wave field—developments which are bringing to this branch of radio thousands of new "thrill seekers." Experimenters, as in the early days of Radio, again have the opportunity to bring about stirring new inventions. Read in **SHORT WAVE CRAFT**, the *Experimenter's Magazine*, how you can build your own Short Wave Sets, both transmitters and receivers. **SHORT WAVE CRAFT** is exclusively a short wave magazine—the kind you have wished for so long.

Regular Departments in SHORT WAVE CRAFT

- Photographic Section—pictures of latest short wave sets and stations;
- Transmitters for short waves and how to build them;
- Short wave receivers—construction of all types and kinds;
- The Short Wave Experimenter;
- Television on Short Waves;
- Short Waves for the broadcast listener;
- Ultra Short Waves;
- Aircraft Short Wave sets;
- How to build Short Wave aeriels;
- Short Wave Question Box.

Interesting Articles in the Current Issue

- Short Waves Highly Important to the New U. S. Navy Dirigible
- New All-Wave "Super"
- Short Wave Signals Direct from Plane to Auto
- What Can We Do with the Ultra-Short Waves?
- All-Electric, Single Dial Tuning, S-W Super-Het
- Combination Long and Short Wave Receiver
- The "Gem" Short Wave Adapter
- How to Neutralize Transmitting Amplifiers
- An A.C.-D.C. Dynatron Oscillator
- Push-Pull Transmitting Circuits
- New S-W Superregeneode

SPECIAL OFFER COUPON

SHORT WAVE CRAFT RC-11
 98 Park Place, New York, N. Y.
 I enclose herewith my remittance of \$2.00, (Canada and foreign \$2.50) check or money order preferred, for which you are to enter my subscription to **SHORT WAVE CRAFT** for One Year, also send me the last two issues gratis. I understand that the regular subscription rate is \$3.00 and this offer will be void after October 31. **SHORT WAVE CRAFT** is published every other month.

NAME

ADDRESS

CITY..... STATE.....

A "Speed Tester" for Radio Service

An entirely new thought in radio service instrument design; and one which will interest many.

By R. DOUGLAS CLERK

REALIZING that many Service Men are anxious to have details of my "Speed Tester," which has made it possible for me to make an average of over 20 calls per 8 hour day, I am now submitting detailed directions for duplicating this extraordinary piece of apparatus.

It all came about from figuring the large amount of time wasted in locating trouble in multi-tube sets even when using the most up-to-date analyzers.

Every radio Service Man knows all about it; remove a tube, put the analyzer plug in its socket, place the tube in the tester, push "umpteem" buttons or twist a multi-switch, and read at least one meter for each setting. Then compare this reading with a chart, or more than likely trust to memory, remove the tube, remove the plug, replace the tube in the set, and then proceed to the next tube which you treat in similar fashion.

We all do it—just like the blind leading the blind, and what a waste of valuable time! Anyone able to run a complete test on *one* tube and its attendant circuits in less than one minute is a veritable whirlwind! No, we must branch out for ourselves and forget the precedent; we must design a piece of apparatus which will indicate the defective tube or circuit in a

rectifier (which supplies the full high voltage) between the '80 tube and the filter. Connect in a meter and measure the current flowing. Now remove any tube in the receiver and the meter will give a new reading, due to the decrease in the load current.

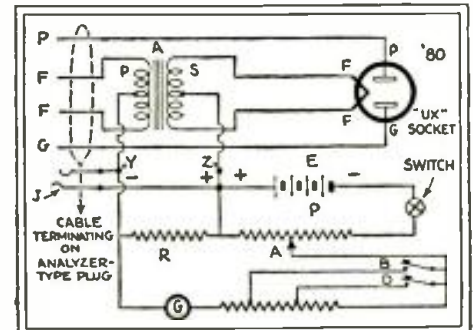

Fig. 3
Schematic diagram of the completed tester.

We can open this lead very easily by using the accursed analyzer plug, which is now in the form of a blessing since we are going to use it *only once*. The plate current supplied by one side of the '80 tube can now be read, but any difference (in current) due to the removal of a tube from the set, which is going to mean so much to us, is too small to be clearly indicated with the meter used—we must make our instrument far more sensitive; we must be able to read differences of a small fraction of a mil. It almost sounds as though we would have to use very expensive laboratory instruments. This, however, is not the case.

Figure 1 indicates where we now stand. Here we have a battery C of any convenient voltage across which is connected a resistor R; another battery E (of higher voltage than C) has a potentiometer P connected across it. These two batteries are so connected that they oppose each other. A meter G, and the necessary "multipliers" in series with it, are shunted across the two resistors P and R, which constitute a potentiometer, with terminals 1 and the arm A.

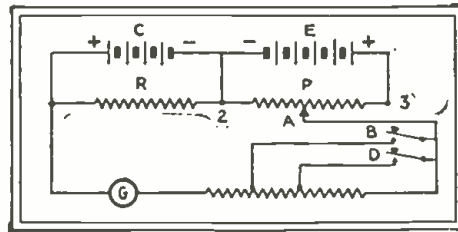

Fig. 1
The fundamental circuit of the "Speed Tester." Position 1, is at the left connection to R.

much shorter time than is possible with present day analyzers. Ninety-nine times out of a hundred there is only one fault in a radio, which, if corrected, will put it in perfect shape.

Here then is our problem. At what point in the circuit can we connect our tester so as to indicate any defect in the set from this one point? Well, there is one place in every radio set where all the "juice" that really matters is concentrated—the "B" supply.

If a tube or circuit is defective in any way, then the current flow from the "B" supply will not be normal; now, if we have instruments sensitive enough to indicate any divergence from normal, then we have located the defective tube or circuit.

Suppose, for instance, that due to some defect we haven't the proper bias on a tube, then the plate current drain of that tube will be greater or less than its normal amount. A weak tube will draw less than it should, and a burnt out tube will not draw any (unless it is shorted, in which case it will draw more than it normally should).

To measure the current flow to each tube is easy; open one lead from the '80 tube

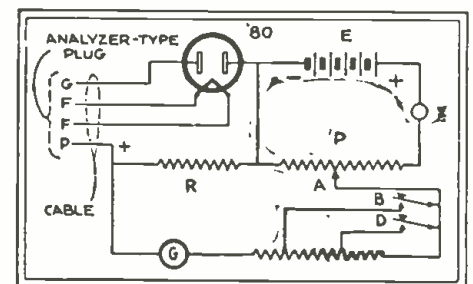

Fig. 2
The potential of C in Fig. 1, here is obtained by the voltage drop across one side of the '80.

If we place the slider of P at the "zero" position (point 2) the meter will read the full voltage of C, and as we increase the adjustment of P toward point 3 the meter will read the difference between C and E (since the batteries oppose each other) until the voltage across the resistor R equals the voltage between points 2 and A, when the difference will be zero, and the meter

G will not read. Now, if we short out a portion of the multiplier of G, we will still get zero for a reading, since the voltage between points I and A is still zero; but any change in voltage C will show up as a big deflection on our meter, due to the decreased resistance in series with the meter. We have made a wonderful increase in sensitivity, which will become greater if we remove more of the multiplier, and can be made still more sensitive if we use a microammeter or galvanometer in place of G.

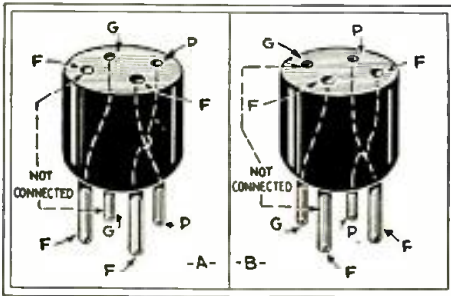

Fig. 5

At A, the adapter for the plug when testing Raytheons; at B, the adapter for the socket of the "Speed Tester."

Now in Fig. 2 we have replaced C by connecting R in the plate circuit of a tester plugged into the '80 socket of a set under test. A voltage is developed across R due to the rectifier current flowing through it, and all the above remarks and conditions are the same as in Fig. 1. If we now balance out the effect of the voltage drop in R, by sliding arm A between points 2 and 3 and then remove any tube from the set under test, we will have a good reading on our meter G, which may be made larger by cutting out more multiplier resistance.

Now we could use the circuit as it stands, but we would get a more accurate picture of conditions if we could include the current from the other plate of the '80. We must not forget that as it now stands we are passing half-wave unfiltered current through both R and G. Not so good. In order to read the total current from both plates of the 80, the resistor R must be connected in the filament circuit. Figure 3 gives the final circuit making use of full wave rectification by isolating through the use of a transformer (which preferably is centre-tapped) the filament circuit of the '80. This is much better for our instrument, but it is still unfiltered; an electrolytic 8-mf. condenser across R helps a lot, but the use of a "thermo-galvanometer" for G is ideal.

Construction Details

As we are going to use a 4.5 volt "C" battery for E, we must design R so that the drop across it is not more than 4 volts. The maximum current supplied by the '80 is rarely more than 100 mils; therefore, R equals $\frac{E}{I}$ equals $\frac{4}{0.1}$ equals 40 ohms. Let us be on the safe side and call it 35 ohms. The potentiometer can be of any high value—10,000 ohms, or more. The multiplier resistor values are determined by the meter used; and as we are wanting comparative readings only, need not be extremely accurate. It should be such that it will give

full-scale deflection when 4.5 volts is applied. Calculate it from R equals $\frac{E}{I}$. Suppose it to be a 1 mil. meter, then R1 equals 4.5

— equals 4,500 ohms, for the total resistance of the multiplier, using a 1000-ohms-per-volt meter. The button D will short out 3,000 ohms, making the meter act as a 1.5-v. meter, increasing the sensitivity 3 times. Button B shorts out all but 500 ohms, giving a further increase of sensitivity.

The transformer, if used, can be constructed on the core of an "AK 37" filter choke (See Fig. 4), and is wound with 90 turns of No. 18 DCC wire for both primary and secondary (each winding is centre-tapped).

Assemble the core in transformer fashion as indicated at A; and not as a choke B. This is to eliminate the air gap required for good operation as a choke coil.

A 4-hole socket, a switch, 2 push buttons, and a four-prong plug, with cable, complete the assembly—which can be mounted on any convenient panel.

If a centre-reading galvanometer (100-0-100) is used, then the polarity of C does not matter; but if a milliammeter is used, then it is necessary to make sure that the E.M.F. across R is connected so that the meter reads backwards when the battery C is not in circuit, and is balanced to zero by the potentiometer P when the switch S is closed. This completes your "Speed Tester."

Operation

To operate the instrument, place the '80 tube in the tester socket; place the plug in the '80 socket with the set turned on. If using a galvanometer, note the reading of G, which will indicate the normal current drain if all is well. (If using a milliammeter, close switch S and adjust P until the milliammeter reads zero.) Now, either

"CHI-RAD"

Full Information and Best Prices on the **NEW S-M 726 SW** Short and Long Wave Receiver **NEW NATIONAL AC 5 SW** Using 235 and 245 Tubes Can Be Had By Writing to Us

National Distributors **MERSON CONDENSERS** Full Line in Stock

Supplies of All Kinds for Short Wave Experimenters

CHICAGO RADIO APPARATUS CO. 415 So. Dearborn St., Chicago, Ill. Est. 1921 Dept. CF-11

The ROOSEVELT



SUPER-HETERODYNE Uses new Pentode power tubes, also new type variable-mu screen grid. 7 tubes in all. 10 KC. separation, wonderful tone and great distance. "Litz" Bank - Wound Coils. The most perfect radio ever built.

Price, complete with tubes **\$64.50**

NEW CUB MIDGET Super Heterodyne. Circuit Pentode, Variable-Mu. Fine Tone. Price complete, \$49.75.

Dealers and Agents: Write for Discounts! **COMMONWEALTH RADIO MFG. CO.** 843-D. W. Harrison St., Cable RADCOM, CHICAGO

PUBLIC ADDRESS EQUIPMENT

MILES REPRODUCER CO. 26 E. 22ND ST. NEW YORK CITY



A Good
SERVICE JOB EASILY DONE
in Half the Time.

TRUVOLT RESISTORS lead in service work because they save time, expense, labor, and they cost less.

The exclusive TRUVOLT Sliding Adjustable Clips enable you quickly to obtain the exact voltages required. The unique open-air winding insures superior cooling and more stable performance. Use TRUVOLT Adjustables and you need fewer resistor sizes, less investment in stock on the shelves, fewer parts in the service kit, and you give prompter service to your customers.

Mail coupon for TRUVOLT catalog

175 Varick St., New York, N.Y.
ELECTRAD

Please send me complete 30 page catalogue with special replacement volume control dial.

Name _____ Address _____

111

RADIO *Experimenters!*

EVERYDAY SCIENCE AND MECHANICS magazine should be of especial interest to every radio man because in this magazine will be found a very fine department on radio construction, radio kinks, radio experimenting, television experimenting, etc. This department is especially important to radio service men.

Then too, this magazine contains a tremendous amount

of other worthwhile experiments and money-making kinks, which, while not radio, are still of great importance to every radio man to keep abreast of the times. No radio man should be one-sided and know only radio. It is just as important to know mechanics and science from the everyday viewpoint because sooner or later you will find this knowledge important in your daily work.

Many excellent pages for the home workshop man who finds pleasure in building things; experiments in electricity, chemistry and formulas of all kinds.

- Just to Mention
- A Few Departments
- LATEST INVENTIONS
- AERO-MECHANICS
- SHOP KINKS
- TELEVISION
- EXPERIMENTS
- FORMULAS
- CHEMISTRY
- WOOD AND METAL CRAFTS
- RADIO KINKS AND OTHERS

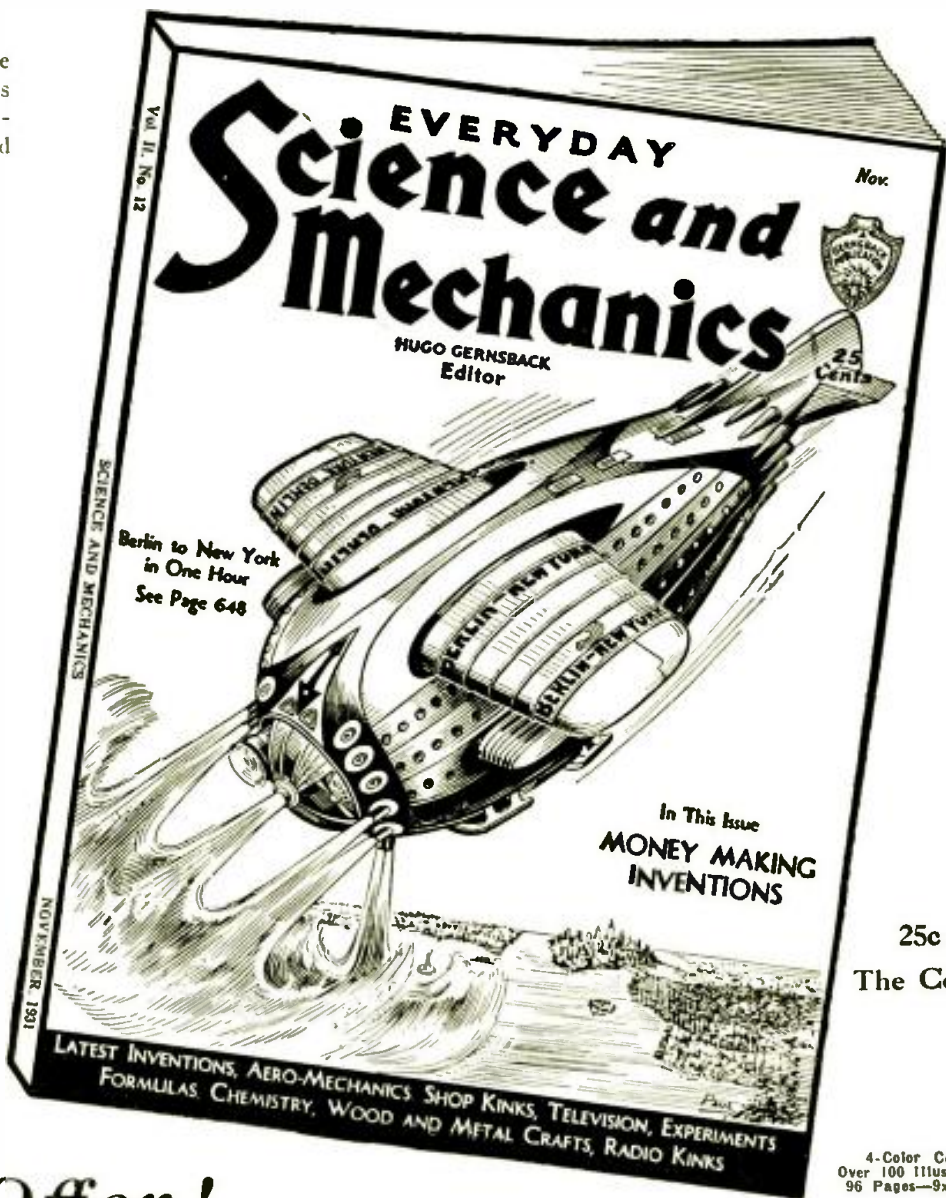

25c
The Copy

4-Color Cover
Over 100 Illustrations
96 Pages—9x12 in.

Special Offer!

8 MONTHS FOR \$1.00

Now On All Newsstands

MAIL COUPON TODAY FOR SUBSCRIPTION

EVERYDAY SCIENCE AND MECHANICS RC-11
98 Park Place, New York, N. Y.

I enclose herewith one dollar for which you are to enter my subscription to EVERYDAY SCIENCE AND MECHANICS for the next Eight Months.

Name

Address

City..... State.....
(Canada or foreign subscriptions not accepted at this rate.)

switch off the set or remove the '80 and read the meter. This reading, which is made before any balancing adjustments are performed, is to be recorded.

With the set switch on and the meter then balanced at zero, press button D to increase the sensitivity and make any further adjustments of P necessary to get a zero reading; remove any tube from the set and compare the reading with a chart; if all is well with this tube and its associated circuit, we will obtain a similar reading every time we test the same stage in a similar set. This reading is the "normal" one to be used in making up our chart for this particular set. However, if the bias or plate supply to this tube is not right, then the reading will differ from normal, thus indicating a defective circuit or tube.

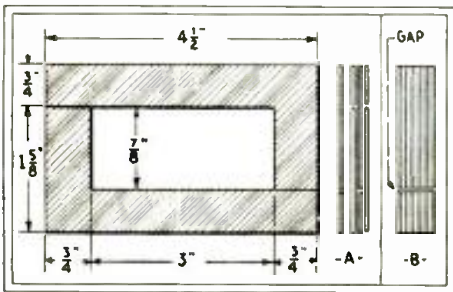

Fig. 4

The laminations should be so arranged (A) that no air-gap exists in the core.

Now remove each tube in turn, and make a comparison with the chart for that particular type of set. Disregard all normal readings and concentrate on those which are abnormal. Use an ordinary analyzer on the defective circuit, substituting good tubes if necessary, and the work is done almost before it is started.

Each model of every make requires a one-line chart showing normal current flow before bucking out the current with potentiometer P, and one value for each tube in the set. I suggest that as no two testers will be alike, that each tester have its own set of charts made by the constructor; using the vertical column to the left, on charts ordinarily supplied with every commercial analyzer. This chart can only be made by taking readings on a perfect set of each model, and recording the normal values.

To service battery-type sets, open the "B—" to the set and connect the "Speed Tester" into the circuit via jack J, Fig. 3, and proceed as in servicing A.C. sets. Receivers using '81's can also be tested with this instrument, but sets using gaseous rectifiers (Raytheons) require one adapter for the plug and another for the socket, the construction for which is shown in Fig. 5.

As further refinements are made in this interesting tester, they will be published.

FOR PROGRAMS' SPONSORS

ADVERTISING'S development is shown in the announcement of a large advertising agency (N. W. Ayer & Son) that their new offices in New York City include "a radio studio fully equipped for transmitting programs to several conference rooms, in which advertisers may hear their programs precisely as they will sound when put on the air. From the new studio programs may be broadcast direct by land-wire hook-up with transmitting stations."

GREATEST TUBE SALE OF 1931

THE LARGEST VARIETY OF TUBES IN THE WORLD

All tubes are guaranteed to be first-grade quality—comparable to the best obtainable on the market today. We will replace within 30 days any tube that has not given complete satisfaction.

Such an amazing tube sale has never been conducted.

COMPLETE STOCK ALWAYS READY FOR IMMEDIATE SHIPMENTS

Order from this page and note the following terms: No order accepted for less than \$5.00. It is not necessary to send the full amount of cash with the order as long as your order is accompanied by 20% of the value. Shipment will go forward to you by express or parcel post C. O. D. All prices are F. O. B. Factory, Newark.

UX-201A	.30	Special radio frequency 201A—	.60
UX-226	.30	a super-sensitive 201A	.60
UX-227	.30	Special audio frequency 201A—	.60
UX-171A	.30	a super-sensitive	.60
UX-171	.30	Special 171A 1-2 amp. extra	.60
UX-129	.30	coated filament	.60
UX-129	.30	T-11 (210A High Mu) high ends	.60
UX-199	.30	slon	.60
UX-199	.30	Switch tube, 201A or 112 or 171	.60
UX-199	.30	double life—all in one	.60
UX-199	.30	Adapted tube 226, 227, 171 A, to	.60
UX-199	.30	convert bat. sets to AC. yacht.	.60
UX-210	.40	UX-210—For power amplifier	1.10
UX-204A	.40	UX-250—Power amplifier	1.10
UX-221	.40	Ballast tube	1.00
UX-245	.40	UX-222—Screen grid	1.10
UX-245	.40	Tellon Television Tube 1" Cath-	3.85
UX-245	.40	ode Square	3.85
UX-245	.40	Tellon Television Tube, 1 1/2"	3.85
UX-245	.40	Cathode Square	3.85
UX-245	.40	Photoelectric cell "Caesium"	5.85
UX-245	.40	Size overall 3 1/16"	5.85
UX-245	.40	Size overall 1 1/4"	7.90
UX-245	.40	Photoelectric cell "Potassium"	3.85
UX-245	.40	WD-11—Detector Amp.	.60
UX-245	.40	WD-12—Detector Amp.	.60



Photoelectric Caesium Type cell.

125 MIL. rectifying tube (B. H. type)	\$1.40
6/10 amp. triode charger bulb	2.00
2 amp. old and new type charger bulbs (list \$1.00)	2.00
our price (Tungar Type)	3.75
UX-230—Used as a full-wave rectifier for high emission	.40
UX-281—Half wave rectifier	1.10
Rectifying Tube especially designed for use with Freshman Master "B"	.30
Eliminator UV brass base. Limited quantity	5.00
UX-806—Half-wave Rectifier mercury vapor	5.00

DISCOUNTS: 100 tubes and over 10%. 500 tubes and over 10% and 10%



NEW TYPE TUBES

UY-236—Screen Grid Radio Freq. Amp.	.85
UY-237—Detector Amplifier	.85
UY-238—Power Amplifier Pentode	.85
UX-230—Dry cell amp. and detector	.60
UX-231—Dry cell amp.	.60
UX-232—Dry cell screen grid amp.	.60
UY-211—Power pentode	.85
UY-235—Super control screen grid amp.	.85
UY-251—Variable Mu	.85

ARCO TUBE COMPANY

38-40 PARK PLACE, NEWARK, N. J.

NEW ADAPTERS FOR PENTODE TUBES

The new "NA AD" Adapter No. 954 KPC is used for replacing the 245 tubes with the new 247 Pentode Tube. Last \$1.00 each

The following adapters make possible the testing of tubes and tube circuits of the new 33, 37, 47, type tubes in your present checker or analyzer.

954 KPC for use with Jewell 209 and 210 Tube Checkers	1.00
" " " Dayrad	1.00
" " " Sterling	1.00
974 for use with Jewell Analyzers	2.50
945GL & 954GL for use with Weston 547, 565, 566	1.50
975 for use with Weston Tube Checker 533, 555, 565	1.00
Supreme Tube Testers	
975II for use with Hickok Sq 4000	2.50
954K for use with Sterling Set Testers	1.25
976 & 977 for use with Supreme 400 Series 976	1.50
977	1.75

"ALDEN'S" New Analyzer Plug Handle with "Locking Feature" for Adapters. The analyzer of every serviceman should be equipped with the new plug. It is no longer necessary to attach Adapters by means of screws. New Adapters for every purpose equipped with center stud which securely locks to Analyzer Plug. Simply insert the plug into Adapter. It locks itself. Snap the button and the Adapter is off. "It is done quicker than said."

904L Analyzer Plug with UX Base	List \$3.00
905L Analyzer Plug with UY Base	List 3.00

Can be furnished with any length cable completely assembled. Simply add symbol "C" to part number.
 UX Base is furnished with 6 wire braided cable. Four wires connected to prongs one wire to screen grid and the sixth to center latch.
 UY Base has six wires five to prongs and the six to screen grid.
 904LC with five foot cord. List \$5.00
 905LC with five foot cord. List 5.00
 For each additional foot. .25
 945 D. S. UX to UY Adapter for use with 904L Plug. Cathode circuit connected to center post. 1.25
 954 D. S. UY to UX Adapter for use with 905L Plug. 1.25

Also Adapters for tube changeovers or with tapped circuits, split circuits and any connection desired. We have or will make the Adapter to meet your needs. Molded and Laminated Sockets, Cables and Speaker Plugs. Send for Free Catalog.

ALDEN PRODUCTS COMPANY

Operating Alden Manufacturing Co.

715 Centre Street

Dept. T

Brockton, Mass.

RADIO'S GREATEST SERVICE MANUAL

is now in the process of preparation. Be sure to read the announcement on page 262 and learn about the many new things that are to be incorporated in the 1932 OFFICIAL RADIO SERVICE MANUAL.

A Most Important and Timely NEW Radio Publication

HERE is the latest book, and one of the most important which we have ever issued. It fills a long-recognized want; for there is not a Service Man or a radiotriician who has not an immediate use for this welcome book.

It is the first book that explains COMPLETELY the operation of analyzers, tube checkers, oscillators, etc., from a thoroughly practical standpoint. The book is intended for Service Men of all classes, whether junior grade or expert. Everyone will find a tremendous amount of "meat" in its pages. Nothing has been left to your own ingenuity; everything is complete.

The contents:

CHAPTER 1
Introduction

The Problems of the Service Man
General Description of Modern Receivers
The Need for a Radio Set Analyzer
What to Expect from an Analyzer

CHAPTER 2
The Analyzer

The Fundamental Requirements of an Analyzer
The Switches or Push Buttons
The Ammeter
Multiscale Ammeters
The Shunt and Its Calibration
The D.C. Voltmeter
The Multi-scale D.C. Voltmeter
The Multiplier and Its Calibration
The A.C. Voltmeter
The Design of a Simple Analyzer

CHAPTER 3
Trouble Shooting with the Analyzer

Classification of Trouble—
(1) External to the receiver;
(2) In the receiver proper:
(a) Mechanical troubles;
(b) Electrical troubles.

Detailed Analysis of Electrical Troubles—
(1) Tube Testing;
(2) Localizing trouble:
(a) By past experience;
(b) By actual test of circuit.
(3) Interpretation of analyzer readings;
(4) Tube charts (use of);
(5) Circuit diagrams (use of);
(6) Testing the power unit;
(7) The use of the analyzer in testing individual units.

Additional Features and Uses of the Analyzer—
(1) As a modulated R.F. oscillator;
(2) As a means of finding up R.F. and I.F. amplifiers;
(3) As an output meter.

Care and Maintenance of Analyzers
Conclusion and Brief Summary

CHAPTER 4
Detailed descriptions, photographs, and circuit diagrams of commercial set analyzers.

This book is sold at a ridiculously low price, because it is our aim to put this valuable work in the hands of 100,000 Service Men and Radiotriicians before the end of this year. Published by RADIO-CRAFT magazine, it has included in it all worth-while information available to the radio servicing profession; and for that reason the price of the book is kept at a very nominal figure.

We know that, if you are at all interested in radio service work, you will send at once for this valuable book.

50c The Copy

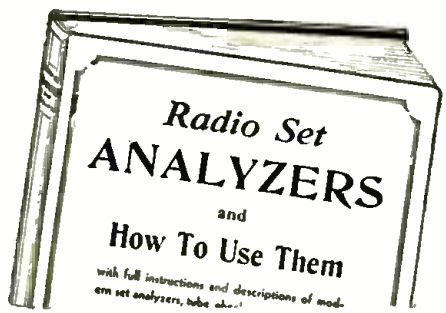

Rush Coupon TODAY!

GERNSBACK PUBLICATIONS, Inc., RC-11
96-98 Park Place, New York, N. Y.

I enclose herewith fifty (50c) cents, for which send me a copy of your book "Radio Set Analyzers and How to Use Them."

Name

Address

City and State.....

Correspondence

(Continued from page 294)

theory in such a way that it includes every process in the whole chain of wireless events, from the microphone at the transmitter, to the loud speaker at the receiver.

The principal features which must be considered in conjunction with the sideband theory, and which had not been considered up to the time of the publication of my paper, are, firstly, the damping of the receiver, and secondly, the rectifier.

Dr. JAMES ROBINSON.

Editor, RADIO-CRAFT:

Doctor Robinson is correct in the above statements. At the time I prepared the Stenode article for RADIO-CRAFT little was known about the system in this country and I gathered as much data as I could from foreign sources; and while much of this was contradictory and incomplete, I connected the information together in a form that apparently explained the complete system in the only logical manner possible.

It is not a question of whether or not sidebands exist. Dr. Robinson never said that they did not exist. They exist in the same manner that various components of forces exist in a parallelogram of forces, although the net result acts in one direction. The main question centers on the width of the frequency-response band of the quartz crystal, which is as yet, I believe, not definitely known. The crystal reacts so strongly on the associated circuits that an exact measurement is very difficult to make. (See note below.)

The crystal acts as a filter. If it was 100% perfect, it would filter out all modulations and would pass only an undamped wave of the frequency of the carrier. But it is not a perfect filter; therefore it passes modulations, the amount depending upon the frequency of the modulations. The higher the modulation frequency, the less it passes, and vice versa. This is the same as saying that the higher the sideband frequency, the more it is "cut," by the selective circuit. And the resultant audio quality would be poor; the high notes would be considerably weakened, and the tone would sound deep and drummy.

For this reason it was assumed, since Dr. Robinson claimed to obtain excellent tone quality, that frequency modulation existed to a slight extent in all amplitude modulated waves. A test indicating that the frequency of some broadcast stations do not vary by more than two cycles in the course of a few hours would not affect the deduction, because the frequency modulation considered would be that which varied at a rate up to 5000 per second, and would be present only when the carrier was modulated in the usual way. I was not aware that any tests had been made to measure the amount of frequency modulation, if any, present in the ordinary broadcast wave; but it would only have to be very slight to affect the highly selective crystal circuit in the Stenode. I would like to see a test made with a Stenode receiver tuned to a transmitter which was only frequency modulated.

There is one point about the Stenode which I believe needs further explanation. In the Stenode, the audio quality at the detector output is very poor; the sidebands

are cut so much that the high notes are reduced far below normal, the volume tapering off considerably as the frequency increases. To compensate for this, the audio amplifier is designed to give the opposite effect; that is, amplify more efficiently as the frequency increases, so that the net result is a practically straight line characteristic giving true tone quality. Now, since the audio amplifier offsets the highly selective characteristic of the crystal circuit, why isn't the net result the same as that obtained from an ordinary set of normal 10 kc. selectivity?

However, the proof of the pudding is in the eating thereof. I have recently had the pleasure of having the Stenode completely demonstrated to me, and as far as results are concerned, it certainly does all that is claimed for it. By direct comparison with one of the better class superheterodyne sets of the usual variety, the Stenode was actually superior in tone quality, and gave even better response on the higher audio frequencies. And as to selectivity, stations that could be heard over a few degrees on the dial of the ordinary set could be tuned completely in and out on the Stenode on a motion of the dial so slight that the eye could hardly perceive it.

CLYDE J. FITCH.

(Note.) Graphs of the response of quartz plates for extensional modes (involving areal dilatation) and that mode termed by him "longitudinal oscillation" which involves displacements which are directed principally parallel to the thickness; and also corresponding values of decrement, are given by A. Meissner in the Proc. I.R.E., Vol. 15, 1927, pp. 281 to 296.

Although the latest results of the experiments of K. S. Van Dyke, which are being conducted at Wesleyan University, Middletown, Conn., have not as yet been published, formulas he derived for the analogous constants of quartz plates (from which at least indications of the probable decrement may be gained), have appeared in the Proc. I.R.E., Vol. 16, 1928, pp. 742 to 764.

Sound Recording

(Continued from page 289)

previously stated); that is, by making a record as the pointer fluctuates about a certain point in the scale. If the record is too loud, the gain must be cut down and the test made over again.

The 250,000 ohm potentiometer P1 in the grid circuit of V1 is used for varying the voltage of the input signal to the tube, thus determining the maximum (three-quarter) swing of the needle of meter M.

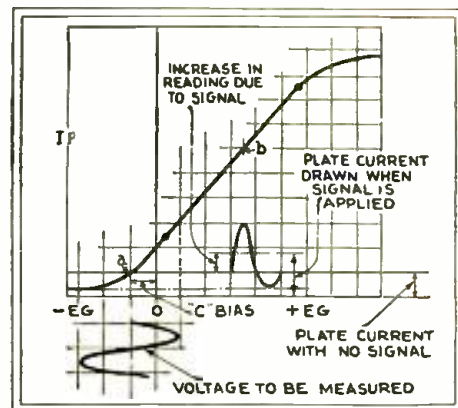

Fig. 5

Due to the non-linearity of the grid-voltage plate-current curve, the average plate current is greater with a signal than without one.

STOP SHOPPING!!

HERE'S a NEW plan, which saves you money. Stop shopping—the lowest prices are right on this page. Yes, lower than in our own catalog. Why? Because no house can get out a new catalog every month, but by advertising in this magazine we can bring

you the latest and lowest prices up to the time this ad is printed. We watch our competitors and do not allow anyone to undersell us. We meet ANY price on NEW merchandise. Order direct from this page and save money. 100% satisfaction on every transaction.

Patent "250" Power Auditorium Amplifier



One of the Most Powerful Super Power Amplifiers ever made.

Now \$8.75

CONTAINS 2 STAGES SUPER POWER A.F. AMPLIFICATION

This famous amplifier is provided with input and output transformers for working from a phonograph pick-up into a 2000-ohm transmission line or into the coupling transformer furnished with most dynamic reproducers. The tubes required are one '26, one '50 and one '81 rectifier. Where maximum output is not required a '10 may be substituted for the '50 in the output. Automatic adjustment takes care of the discrepancy in voltages. The undistorted power output is 2.5 watts—enough for four small dynamic reproducers. This degree of power output provides satisfactory coverage for auditoriums having a volume of 25,000 cubic feet. The input voltage necessary to provide maximum output is but 92.5 volts.

Ideal for theatres seating approximately 3,000 people, dance halls, schools, lectures, hospitals, auditoriums, outdoor gatherings, etc., etc. The gigantic power is at all times within control—for that matter, it can be used in any home, as the volume can be regulated down to a whisper!

A PHONOGRAPH AMPLIFIER—PUBLIC ADDRESS AMPLIFIER SYSTEM, ETC.

Use of the '26 tube in the input stage makes the long "warming up" period unnecessary. Shipping weight, 30 lbs. Overall size, 16 x 9 1/2 x 6 1/2" high. List Price, \$90.00.

No. 1925—Patent Model 250 Power Amplifier (less tubes). Your Price \$8.75

BRAND NEW! RADIO MIRROR PENLITE



The Latest and Cleverest Tool for Radio Servicemen. The only device that enables you to LOOK AROUND CORNERS or UNDERNEATH inaccessible spots. Your vision is ONLY in a straight line, but with the Mirror-Penlite you can look around a 45 degree angle. You can now look under the whole chassis and see every nut, every wire, every socket, behind condensers, transformers, etc. This is made possible by the powerful pocket flashlight to which is attached a GENUINE DENTAL MAGNIFYING MIRROR. Mirror clips on or off so flashlight can be used alone if desired. The cleverest device yet. Complete with battery and bulb. Shipping weight 6 ozs.

No. 1695—Mirror-Penlite. List Price \$2.50. YOUR PRICE..... 85c

Earl Power Transformers

Make money revamping the old battery set. This power transformer used in Earl Model 22 receiver supplies "A," "B," and "C" potentials for two '27's (for screen-grid '27's), three '26's, two '71A's and one '80 rectifier; total current output of high-voltage winding at maximum output (about 200 volts) is 80 ma. High-voltage secondary, filament winding for '27's and for '71A's are center-tapped. Size, 3 1/2 x 3 x 2 1/2 inches. 16 long leads and full wiring directions. Shipping weight 5 lbs. List Price, \$7.50.

No. 1410—Earl Transformer (with-out brackets). YOUR PRICE..... \$1.73

No. 1411—Earl Transformer, the same but with mounting brackets.. \$1.98

SPECIAL!

Baldwin RIVAL Speaker Unit
A loud speaker unit bearing the world famous Baldwin mark. Designed for use with horn type speakers or with old style phonographs. Complete with cord. Shipping weight 1 lb. POSITIVELY LOWEST PRICE THIS UNIT HAS EVER BEEN SOLD.
No. 1520—Baldwin "Rival" Unit.
YOUR PRICE..... 45c

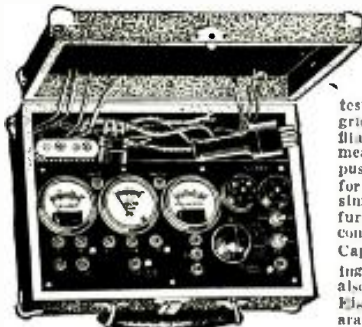

NEW READRITE Analyzer

This three-meter analyzer has selector switch for checking all parts of tube circuits by connecting to the set sockets. Selection for testing voltages of plate, grid, cathode and screen-grid done quickly and accurately. Plate current, filament volts, line and power supply volts are measured. Grid swing test for tubes used. Just push one button for screen-grid and other button for other tubes. Makes testing of all type tubes simple and thorough. 4 1/2-volt grid battery is furnished. Battery is used for grid test and continuity testing of transformers, chokes, etc. Capacity and resistance charts furnished showing use of instruments for testing condensers, also measuring resistances up to 100,000 ohms. Eight scale readings of meters may be used separately with the jack terminals provided. Scale readings are 0-60-300-600 D.C. volts, 0-10-110, 700 A.C. volts and 0-20-120 milliamperes. A.C. and D.C. filament voltages are accurately measured on the one meter. Strong case with leatherette covering. Attractive. Compact. Size 10 1/2 x 3 1/2 x 3 inches. Shipping weight 15 lbs. List Price \$25.00.

No. 700—READRITE ANALYZER. YOUR PRICE..... \$14.70

New 36 page Summer Edition No. 23



The new Summer Edition of our greatly enlarged RADIO SERVICE TREATISE has just come off the press. If you liked the Winter Issue, you will like this one a hundred-fold. It contains some 75 new hook-ups, circuit diagrams; and some 350 illustrations. POSITIVELY THE GREATEST BOOK EVER PUT OUT BY ANYONE. Among the new matters listed are:

VACUUM TUBE TREATISE, with many illustrations; full page Vacuum Tube Average Characteristic Chart; How to Take Care of Your Tubes; How to Connect Phonograph Pick-ups; Improving the Tone Quality of Old Sets; Connecting Additional Loud Speakers; all fully illustrated with diagrams.

Other articles: Modernizing Old Radio Sets; How to Convert Battery to Power Sets; Selection of Tubes; Push-Pull Amplifiers; Replacing Audio Transformers; Phono Attachments; How to Choose Power Transformers; Voltage Dividers; Wattage of Power Transformers; Selecting and Installing Replacement Parts in Radio Sets; Filter Condensers; Repairing Eliminators.

WRITE TODAY. Enclose 2 cents for postage. Treatise sent by return mail.

75 New Hook-Ups, etc.
350 Illustrations.

NEW! NEW!!

Superheterodyne S-W Converter



At last a short-wave converter that converts any broadcast set into a superheterodyne short-wave receiver. Employs three 227 tubes and covers from 20 to 115 meters. No plug-in coils! Coil switch is used to cover all wavelengths. Single dial control, no body capacity, no squeals. This converter has built-in filament transformer to heat the three 227's.

All you need to obtain from your receiver is a positive B voltage anywhere from 45 to 180 volts. Voltage is not critical; no modulation of the receiver. So simple a child can operate it. Size 7 x 10 x 5 inches. Shipping weight, 8 lbs. List Price \$25.00.

No. 1614—Super Converter (less tubes). YOUR PRICE..... \$14.69

World-Wide Short-Wave Set NOT A CONVERTER

A perfect radio short-wave receiver for use between 17 and 81 meters. To put into operation, connect antenna, ground, 45-volt "B," and 6-volt "A" batteries, and headphones to the posts provided, plug in a type '01A tube, and tune in! An ingenious circuit makes possible a 4-coil single-winding plug-in design. This little instrument has the same sensitivity as many big, shielded short-wave receivers costing ten times as much. A power amplifier may be added for any degree of volume. Complete with 4 plug-in coils. Has fine vernier dial for precision tuning. Never has a first class short-wave set sold for so little money. This short-wave set measures 5 1/2 x 7 x 1 in. high, over all. Ship. weight, 3 lbs. List price, \$12.50.

No. 1686—World-Wide S.-W. Set. \$6.25 Your price.....

6 MONTHS GUARANTEED NEONTRON TUBES

Sold on a 6 MONTHS FREE REPLACEMENT GUARANTEED BASIS, PROVIDING TUBE LIGHTS! All tubes are carefully meter-tested before shipment, and carefully packed. Do not confuse these HIGH QUALITY tubes with any other "low priced" tubes—our low prices are possible because we do a VOLUME business!

Choice	Choice	Choice	Choice	Choice	Choice
226	112A	245	222	230	235
227	200A-199X	280	210	230	247
171A	190V-120	171	250	231	
201A	221		281	232	
63c ea.	69c ea.	79c ea.	1.58 ea.	1.08 ea.	1.50 ea.

R.C.A. LICENSED TRIAD AND PERRYMAN TUBES

These nationally advertised tubes are guaranteed UNCONDITIONALLY for six months. The prices are slightly higher than our NEONTRONS because these tubes are of much better quality. See listing above for tube numbers.

Choice	Choice	Choice	Choice	Choice	Choice
Price	Price	Price	Price	Price	Price
76c	96c	86c	\$1.76	\$1.46	\$2.09

THORDARSON

"245" Power Transformer

A Miniature Power Plant — Supplies All ABC Voltages — 80 Watts



In addition to supplying a full 250 volts to the plates and 50 volts to the grids of two type '45 tubes in push-pull, this transformer may be used to light the filaments of seven or eight 2.5-volt filament tubes; and by connecting in series two of the three 2.5-volt filament secondaries it is possible to light 3-volt filaments too. Five secondaries: S1—3 V., 2 Amp.; S2—310 V., Cent. T.; S3—2 1/2 V., 3 Amp.; Cent. T.; S4—2 1/2 V., 10 1/2 Amp.; S5—2 1/2 V., 3 Amp.; Cent. T. Just the power transformer for building up a high-grade public address amplifier to use a screen-grid A.F. amplifier to boost the output of a microphone or phonograph pick-up; following this with two stages of push-pull amplification consisting of two '27's in the first stage and two '45's in the second. Bottom of transformer has bakelite panel on which are mounted all taps. It outperforms ANY similar transformer. Many Service Men keep this model transformer on hand for emergency replacements in hundreds of makes of radio sets. For 110-120 volts, 50-60 cycles. Size: 5 in. high x 4 x 3 1/2 in. Shipping weight, 8 lbs. List Price, \$15.00.

No. 1450—Thordarson Power Transformer. YOUR PRICE..... \$3.84

Flewellling-Dayton SW Adapter

This wonderful instrument connects to any A.C. radio set by putting into tube socket in place of the tube which must be a type '27, or "heater" tube the plug which is on the end of its 2-ft. cable; then put tube into tube-socket of adapter. Remove aerial from broadcast set and connect to antenna post on adapter. Special plug-in coil No. 1 covers a wavelength band of 17 to 29 meters; coil No. 2, 27-28 meters; coil No. 3, 47-81 meters. Plug-in coil inductances come with the adapter. 5 1/2 x 7 1/2 x 1 1/2" high, overall. Ship. weight 4 lbs.

No. 1613—Dayton Flewellling Short-Wave Adapter. List Price, \$15.00. YOUR PRICE (without tube).... \$4.93

Short-Wave Converter

Build a short wave converter at lowest price on record, but with which excellent results are obtainable nevertheless. The voltage for the three 227 tubes used may be obtained from an external filament transformer or from a secondary winding of 2 1/2 volts in a power pack. Wavelength from 30 to 110 meters. No plug-in coils; coil switch is used to cover wave band. Single dial tuning—no squeals, no body capacity, no squeals. Leak-condenser modulation. Converter consisting of all parts (less filament transformer) including cabinet, panel, diagram and 1-page instruction sheet (less tubes).
No. 1619—YOUR PRICE..... \$4.85
No. 1615—6-Volt Battery Model, same price.

High-Voltage Condenser Units

We guarantee these condensers unconditionally. They are ideal for general replacement purposes and can be installed in any new power-pack. All condensers are furnished with 8-inch lengths of tinned "push-back" wire.

600 VOLTS			800 VOLTS		
Cat. No.	Mfd. Capac.	Your Price	Cat. No.	Mfd. Capac.	Your Price
1702	1/2	\$0.25	1706	2	\$0.40
1703	1	.30	1707	2	.70
1704	2	.40	1708	4	1.05
1705	4	.60			

WE ARE A WHOLESALE HOUSE AND CANNOT ACCEPT ORDERS FOR LESS THAN \$3.00.

If C. O. D. shipment is desired, please remit 20% remittance, which must accompany all orders.

If full cash accompanies order, deduct 2% discount. Send money order—certified check—U. S. stamps.

Radio Trading Co.
23 West Broadway
New York, N. Y.

ORDER FROM THIS PAGE. You will find special prices from time to time in this magazine. Get our big FREE catalog for the greatest Radio Bargains.

Should you wish goods shipped by parcel post, be sure to include sufficient extra remittance for same. Any excess will be refunded.

Sonora

CLEAR AS A BELL



PEERLESS 12" AUDITORIUM DYNAMIC SPEAKER

The Peerless Dynamic Speaker is positively the last word in efficiency and powerful reproduction. As a suitable companion it is housed in a beautiful two-toned Sonora walnut cabinet of excellent workmanship. This speaker is properly fitted in a chamber 15" deep, 17 $\frac{3}{4}$ " wide and 18" high. The front is baffled with $\frac{3}{4}$ " thick baffle board cut out to fit the cone of the speaker. No rattling, no distortion but just a perfect reproduction of sound. Built with double heavy duty A.C. rectifiers and the famous Elkon hum condenser added makes reception perfect. For that matter it is equally suited with ordinary sets, employing the average type of audio amplification systems, using as low as 90 volts "B" current.



Will work with any set, regardless of output characteristics. Overall dimensions: 40" high, 24" wide, 12" deep. For 110 volts, 50-60 cycle A.C. Shipping weight, 60 lbs.

List, \$155.00
OUR NET PRICE ... **\$19.50**

PHOTOELECTRIC CELLS

Potassium Type \$3.90
Caesium Type, small 5.90
Caesium Type, large 7.90

TELEVISION TUBES

1" Cathode \$3.90
1 $\frac{1}{2}$ " Cathode 3.90

NEW TUBES AT \$1.00 EACH

1X 230	1X 236
1X 231	1X 237
1X 232	1X 238
1X 235	1X 551

A-B-C POWER PACKS

There are now available to the Service-Man, experimenter, and custom set builder three models of power packs designed to supply "A," "B," and "C" potentials to radio receiver chassis of almost any type. Each pack is complete with voltage divider, filter condensers, filter choke, by-pass condensers, and taps for intermediate voltages (R.F., Detector, A.F., etc.) Two leads are provided for connection to a dynamic reproducer field; or the circuit may be completed through a filter choke supplied with each instrument, where the reproducer is a magnetic, or self-powered dynamic unit.

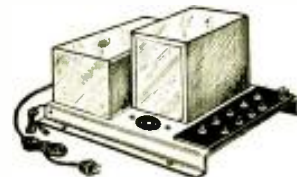

Pentode, screen-grid, variable-mu, and all the other tubes may be powered from one of these packs. The characteristics of each are as follows:

Type A. Filament supply for four type '26 tubes, one '27, two '71A's, and an '80. Plate Potential, 150 volts; and the "C" voltage requisite for type '71A tubes.	Type B. Filament supply for four type '24 or '27 tubes, two '45's and an '80. Plate potential, 180; and "C" for the '45's.	Type C. Filament supply for four type '24 or '27 tubes, two '47 pentodes, and an '80 rectifier. Plate potential, 250 volts; and "C" for the '47's.
---	---	---

Each of these units is provided with taps supplying the usual R.F., detector, and A.F. voltages. These A.B.C. Power Units are going like hot-cakes

OUR PRICE FOR ANY TYPE **\$6⁷⁵**

MAGNAVOX DYNAMIC SPEAKER MODEL 130

130 Push Pull 245 (5000 ohms).
130 Push Pull 245 (2500 ohms).
130 Single 245 (2500 ohms).
130 Single 245 (5000 ohms).
Cone and required Baffle Hole Diameter 7 $\frac{3}{4}$ inches; Height—Base to Center of Cone 4 $\frac{5}{8}$ inches; Overall Height 9-1 $\frac{32}{100}$ inches; Overall Depth 4-1 $\frac{16}{100}$ inches; Overall Width 8-13 $\frac{16}{100}$ inches; Front to Center Line of Front Holes in Three Sided Upright Base 1 inch; Front to Center Line to Rear Holes in three Sided Upright Base 3 inches; Spacing of Holes Upright Base Side to Side 4-13 $\frac{16}{100}$ inches.



OUR NET PRICE **\$3⁴⁵**

MAGNAVOX DYNAMIC SPEAKER MODEL 110

110—Single Pentode (2500 ohms).
110—Push Pull 245 (2500 ohms).

Cone and Required Baffle Hole Diameter 7 $\frac{3}{4}$ "; Height, Base to Center of Cone, 4 $\frac{3}{4}$ "; Height, Overall, 9 $\frac{1}{8}$ ". Depth, Overall, 6-5 $\frac{32}{100}$ "; Width, Overall, 8 $\frac{3}{4}$ ".



OUR NET PRICE **\$3⁴⁵**

All offers are F.O.B. New York, and subject to prior sale. Terms: A deposit of 20% is required with every order. Balance may be paid on delivery. Or, deduct 2% if full amount is sent with order.

DO NOT WRITE FOR CATALOG!

GREN PARK CO., Dept. RC. 245 Greenwich Street, New York, N.Y.

\$

Prices YOU can make a REAL profit on!

\$

Famous Model "G" Gordon Phono-Motor and Turntable

First time at this price. Ruggedly constructed throughout. Spanish felt gears assure silence. Equipped with automatic stop control. Induction type, no brushes. Easy to install—exceptionally quick starting torque. For 110 volt 60 cycle alternating current. Proven dependability has made this New Gordon Electric Phonograph Motor and Turntable the accepted standard of excellence for the industry.



First time at this price. Make a nice profit and build good will with everyone.

List \$30.00
OUR PRICE \$8.95

Farrand Dynamic Chassis

Famed for its simplicity and reliability. Easily installed in all types of radio or phonograph consoles. Tonal range and fidelity superior to any other reproducing unit in general use. Dimension: Height 9 inches, width 8 3/4 inches, depth 7 inches. For A.C. current.

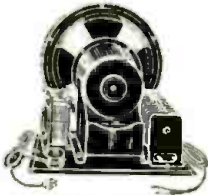

OUR PRICE \$5.95

Condenser Block for Majestic "B" Eliminator



OUR PRICE \$2.75

Replacement for defective blocks in "B" Eliminators—identical in electrical characteristics and outside dimensions. Can also be used in any make "B" Eliminator as well as most power packs

Gordon Acme 4 Pick-Up with Volume Control

Genuine Bakelite arm with beautiful natural wood finish will not show wear as will plated metal. Faithfully reproduces the entire musical range.

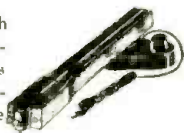

OUR PRICE \$4.50

I.C.A. Test Leads—a necessity to the dealer or serviceman. Unrivalled for testing sets and tracing shorts, opens and other common defects. Easily attached to testing meter or electrical apparatus. **40c**

Fixed Pigtail Resistors

OHMS		
500	10,000	75,000
1,000	15,000	100,000
1,500	20,000	125,000
1,800	25,000	150,000
4,000	30,000	250,000
4,700	40,000	1 Megohm
5,000	60,000	2 Megohms

OUR PRICE 75c PER DOZ

R. C. A. Loudspeaker 103

A beautiful speaker, superb in its faithful reproduction. Molded frame and pedestal resemble hand carved oak. Mechanism concealed by attractive tapestry.



(Genuine R.C.A.)
List \$18.00
OUR PRICE \$3.95

Atwater-Kent

Condenser & Filter Block

For Model 37 and 38 Sets

Ideal filtering system for ANY make A. C. set using 171-A tube. Contains proper chokes and high voltage condensers. Flexible wire colored leads same as original.



HOO-K-UP:
Green wire to 280, black to R.F. plate, yellow to Power Tube plate, white to first audio by-pass, white to C.T. of 226 resistance, red to detector OUR plate. Wire from PRICE can to ground.

\$2.95

Kolster K-6 Speaker

Magnetic type cone speaker. Remarkable tone quality; volume to spare. Beautifully carved, fine Walnut cabinet. Equipped with highly sensitive over-size magnet and driving unit. Faithful reproduction from the faintest whisper to fullest volume of a brass band.



List \$20.00
OUR PRICE \$3.95

AIR-KING

Superheterodyne S.W. Converter

The greatest converter ever built.

Brings in European stations clear as a bell. Converts any set into a short wave receiver. Employs 3-227 tubes; covers from 20 to 115 meters. Coil switch covers all wave lengths. Single dial control, no loose capacity, no squeaks. Has built-in filament transformer to heat the 3-227's. All you need from your receiver is a positive B. voltage from 15 to 180 volts. Voltage is not critical; no molestation of the receiver. Size 7x10x5 in. Weight 8 lbs.

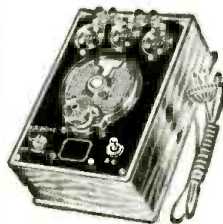

OUR PRICE \$14.70

New Type Elkon Dry Disc Rectifier

Standard on "A" Eliminators for Majestic, Mayolian, Webster, Elkon, Bernard, Fada, Knapp, Sentinel, Metro, General Instrument, Philco (Elkon equipped) and also on Elkon 3 amp. and Briggs & Stratton chargers.

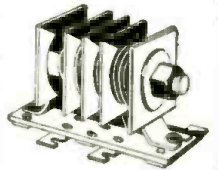

List \$7.00

OUR PRICE \$3.45

Baldwin Rival Unit



This Nathaniel Baldwin unit is one of the finest. For phonograph, automobile and portable radio outfits. We offer this famous unit now at a sensationally reduced price.

OUR PRICE 50c

VICTOR ABC Power Transformer

For use with 6-226, 2-245, 1-227 and 1-280 tubes. Magnetically shielded preventing hum. Can safely be overloaded 30%. High voltages, 400 volts at 150 mils on either side of center tap. Extra large case especially designed to prevent overheating.

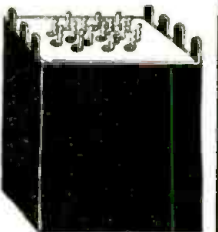

Can Be Used For Any Power Amplifier Using 245 Tubes

Size: 4 1/2 x 5 x 5 1/2 inches.
No. 1—Center tap of 9 and 14 (5 volts).
No. 2 and 4—2 1/2 Volts.
No. 5 and 7—1 in. V. High amp. (226).
No. 3 and 6—Primary (110V. input).
No. 8—Center tap of 12 and 17 (2 1/2 V.)
No. 9 and 14—5 Volts (280).
No. 10 and 15—High voltage for B supply.
No. 16—Center tap of above.
No. 12 and 17—2 1/2 in. volts high amp. (224).

OUR PRICE \$2.10

FREE Catalog—means money to you

These are only a few samples of the values to be found in our catalog. It is full of items on which you can make from 50% to 300% profit. And the best of them is, they are sound, well known, trademarked articles you can depend upon.

Send 20¢ with the order and articles will be shipped C.O.D. Order any of the above articles direct from this page. And be sure to ask for the catalog. It means money to you!

RADIO CIRCULAR CO.

225 Varick St. New York City

ORDER DIRECT...from this page!

TEAR IT OUT NOW!

RADIO CIRCULAR CO., 225 Varick Street, New York City

Enclosed find \$ _____ This is 20% of items listed below. I will pay balance upon receipt of merchandise.

Send for FREE catalog!

RADIO CIRCULAR CO.
225 Varick Street, New York City

Please send me your catalog of radio bargains I can make a profit on.
I understand this obligates me in no way.

Name _____

Address _____

City _____

State _____

Also please send catalog.

I will train you at home to fill a **BIG PAY** Radio Job!



Here's Proof



\$100 a week

"My earnings in Radio are many times greater than I ever expected they would be when I enrolled. They seldom fall under \$100 a week. If your course cost four or five times more I would still consider it a good investment."

E. E. WINBORNE
1267 W. 48th St.,
Norfolk, Va.



Jumped from \$35 to \$100 a week

"Before I entered Radio I was making \$35 a week. Last week I earned \$110 servicing and selling Radios. I owe my success to N. R. I. You started me off on the right foot."

J. A. VAUGHN
3107 S. Grand Blvd.,
St. Louis, Mo.



\$500 extra in 6 months
"In looking over my records I find I made \$500 from January to May in my spare time. My best week brought me \$107. I have only one regret regarding your course—I should have taken it long ago."

HOYT MOORE
R. R. 3, Box 919,
Indianapolis, Ind.,

If you are earning a penny less than \$50 a week, send for my book of information on the opportunities in Radio. It is free. Clip the coupon NOW. Why be satisfied with \$25, \$30 or \$40 a week for longer than the short time it takes to get ready for Radio.

Radio's growth opening hundreds of \$50, \$75, \$100 a week jobs every year

In about ten years Radio has grown from a \$2,000,000 to a \$1,000,000,000 industry. Over 300,000 jobs have been created. Hundreds more are being opened every year by its continued growth. Many men and young men with the right training—the kind of training I give you—are stepping into Radio at two and three times their former salaries.

You have many jobs to choose from

Broadcasting stations use engineers, operators, station managers and pay \$1,200 to \$5,000 a year. Manufacturers continually need testers, inspectors, foremen, engineers, service men, buyers, for jobs paying up to \$7,500 a year. Shipping companies use hundreds of Radio operators, give them world-wide travel with board and lodging free and a salary of \$80 to \$150 a month. Dealers and jobbers employ service men, salesmen, buyers, managers, and pay \$30 to \$100 a week. There are many other opportunities too. My book tells you about them.

So many opportunities many N. R. I. men make \$200 to \$1,000 in spare time while learning

The day you enroll with me I'll show you how to do 28 jobs, common in most every neighborhood, for spare time money. Throughout your course I send you information on servicing popular makes of sets; I give you the plans and ideas that are making \$200 to \$1,000 for hundreds of N. R. I. students in their spare time while studying. My course is famous as the course that pays for itself.

Talking Movies, Television, Aircraft Radio included

Special training in Talking Movies, Television and home Television experiments, Radio's use in Aviation, Servicing and Merchandising Sets, Broadcasting, Commercial and Ship Stations are included. I am so sure that I can train you satisfactorily that I will agree in writing to refund every penny of your tuition if you are not satisfied with my Lessons and Instruction Service upon completing.

64-page book of information FREE

Get your copy today. It tells you where Radio's good jobs are, what they pay, tells you about my course, what others who have taken it are doing and making. Find out what Radio offers you, without the slightest obligation. **ACT NOW!**

J. E. SMITH, President
National Radio Institute Dept., 1 M X
Washington, D. C.

Our Own Home

Pioneer and World's Largest Home-Study Radio training organization devoted entirely to training men and young men for good jobs in the Radio industry. Our growth has paralleled Radio's growth. We occupy three hundred times as much floor space now as we did when organized in 1914.



Special Free Offer



In addition to my big free book "Rich Rewards in Radio," I'll send you my valuable manual "28 Tested Methods for Making Extra Money." Never before available except to students. Now, for a limited time, it is free to readers of this magazine. How to make a good baffie for cone speakers, how to reduce hum in externally fed dynamic speakers, how to operate 25 cycle apparatus on 60 cycle current, how to operate 110 v. A.C. receivers on D. C., how to shield sets from local interference are five of the subjects covered. There are 23 others. Get this valuable book by mailing the coupon now.

Act Quickly

I will give you my new 8 OUTFITS of RADIO PARTS for practical Home Experiments

You can build over 100 circuits with these outfits. You build and experiment with the circuits used in Crosley, Atwater-Kent, Eveready, Majestic, Zenith, and other popular sets. You learn how these sets work, how to make them work. This makes learning at home easy, fascinating, practical.



I am doubling and tripling the salaries of many in one year and less Find out about this quick way to

BIGGER PAY



FILL OUT AND MAIL THIS COUPON TODAY



J. E. SMITH, President
National Radio Institute, Dept. 1 M X
Washington, D. C.

Dear Mr. Smith: I want to take advantage of your special free offer. Send me your two books, "Rich Rewards in Radio" and "28 Tested Methods for making extra money." I understand this request does not obligate me and that no salesman will call.

Name.....
Address.....
City..... State.....

Lifetime Employment Service to all Graduates

EXCLUSIVE NEWS FROM

LINDBERGH PLANE FLYING OVER ARCTIC WILDERNESS, RECEIVED ON A LINCOLN RADIO

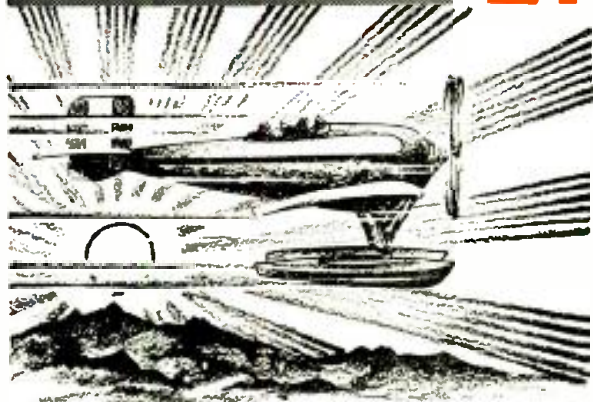

On the eve of August 5th, Roscoe H. Johnson, operator and owner of a powerful short-wave station, using a LINCOLN RECEIVER, had just finished his daily schedule of messages with the Bowdoin ship of the MacMillan expedition, now located off the shores of Baffin Land; turning his dials to the frequency of the Lindbergh transmitter, strong and clear came in the signals from the Lindbergh plane, flying over the Arctic circle. Realizing that this was the first message received for some time from the famous aviator and that the public were much concerned as to the safety of the plane, Mr. Johnson immediately phoned the United Press and in a flash it was headlined in newspapers throughout the world.

When the operator, in Chicago, turned his dials to the 20 meter band, the sharp clear note of the Lindbergh transmitter brought its message through the violent storms and electrical disturbances of the Arctic. Hundreds of amateur and commercial stations in all parts of the world were vainly combing the air for some news of the flying colonel and his wife. It remained for a LINCOLN receiver to catch the anxiously-awaited signal from the far north reassuring the world that all was well.

Such spectacular performance is an impressive tribute to the excellence of Lincoln equipment, and proves, in a conclusive manner, the outstanding superiority of Lincoln receivers.

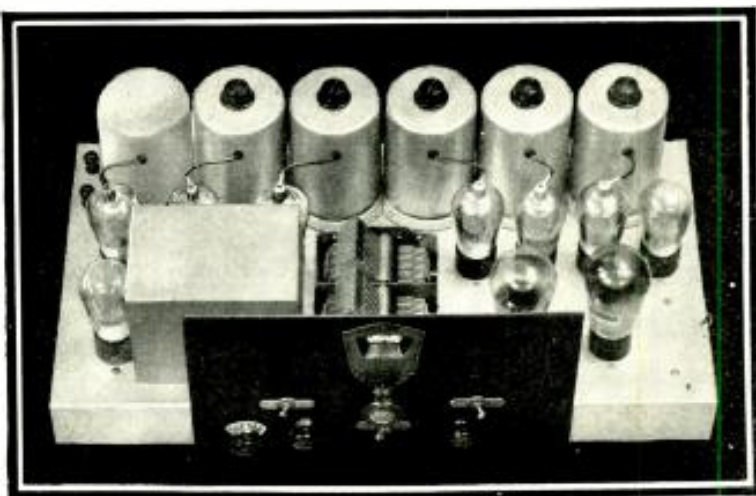

SUPER-POWERED, WORLD-WIDE RECEPTION 15 to 550 METERS - NO PLUG-IN COILS - WITH THE LINCOLN DE LUXE S-W 32 and DE LUXE D.C. SW 10

Now, you can sit comfortably in your easy chair and switch instantly from your local station to London, Paris, Rome, Nauen, Morocco, Saigon, Wellington—over 100 phone stations throughout the world.

No plug-in coils, six screen-grid tubes in the highest amplifying system known WITH PERFECT 10 KC REJECTIVITY famous in Lincoln equipment for the last four years.

Turn the indicator to the desired band of frequencies and apply the full tremendous power of the DeLuxe to Short-Wave or Broadcast signals. Utilizing the tremendous amplification and rejectivity of the famous Lincoln tuned intermediate transformers, originated four years ago and perfected to a high degree, the DeLuxe brings in distant signals with tremendous volume with perfect rejectivity. A Lincoln owner in Tennessee listens to NINETY-TWO FOREIGN SHORT-WAVE STATIONS out of a total of 128 foreign phone stations. Old time "Hams" and radio fans marvel at the tremendous volume available on signals thousands of miles away. Even in the Broadcast band, owners of Lincoln equipment located in the Central West are actually listening to stations 7,000 miles away with loud speaker volume. A report from Cushing, Oklahoma, states: "Seven stations received from Japan in one morning, all in the broadcast band." While another report reads: "Listening to 2YA Wellington, New Zealand, Osaka, Sendai, and Kumamoto, (750, 770 and 790 KC) in Japan, KGMC Honolulu, 2BL Sydney, Australia, all in the Broadcast Band." Do you wonder that Lincoln receivers are classed as the most powerful equipment in the world?

Do you wonder why Lincoln equipment out-performs any known receiver and is chosen by the Polar Expedition, Broadcasting Station, and individuals who want the best?

Months of intensive laboratory study has been put into these two new receivers. Capitalizing on years of advanced engineering developments, Lincoln engineers have worked out every detail of performance—Selectivity—Sensitivity—Fidelity and Stability, to work perfectly from frequencies of 15 to 550 meters. The tremendous amplification of the new models now applied to short-wave, as well as broadcast stations, gives a new conception of what is possible in radio.

MARVELOUS TONE QUALITY for which Lincoln equipment has so long been noted, is maintained. The heavy volume of the organ or orchestra can be brought into the home with realistic reproduction or tuned down to a whisper without destroying the quality and without a sign of AC hum.

EVERY RECEIVER IS LABORATORY BUILT, CONSTRUCTED BY COMPETENT ENGINEERS AND THOROUGHLY TESTED ON THE AIR BEFORE SHIPMENT.



THE LINCOLN DELUXE DC-SW-10

This receiver is designed for use with new low drain series 2-volt tubes, employing three 30 type, five 32 type and two 31 type in push-pull output. Will operate on any two volt "A" supply and dry "B" batteries. For quietness of operation due to elimination of AC line interference, the new DC DeLuxe gives perfect reproduction on extreme distance.

The Lincoln DeLuxe DC-SW-10 is without question the highest designed and most powerful battery receiver ever offered to the public.

LINCOLN RADIO CORPORATION
329 SO. WOOD ST. Dept. R. C. - 11
CHICAGO, ILLINOIS

Write today for Arctic Expedition Bulletin and illustrated descriptive literature with attractive distributors' discount.

NAME

ADDRESS



*“and these Apartments are all wired for Radio
— you’re sure of ideal radio reception through
the **RCA Antenaplex System**”*

One perfect antenna on the roof, and radio outlets all through the building for the convenience of the tenants. Just plug in your set, and it’s ready to work. You get better reception this way than with separate antenna wires,—clean signals, minus the usual local interference from electrical devices throughout the house.



Attention ! RADIO SERVICE MEN

The RCA Antenaplex System solves the apartment house radio problem, delivering 100% of antenna signal energy to every outlet. The lead covered cabloy may be run exposed, concealed, or in metal conduit.

An attractive proposition awaits Radio Service men and electrical contractors who want to promote sales and install this equipment in new or existing structures.

Write for information and illustrated instructions.

ENGINEERING PRODUCTS DIVISION

RCA Victor Company, Inc.

Camden, New Jersey

A Radio Corporation of America Subsidiary



Centralized Radio Systems